

# INDUSTRIAL WET/WET DIFFERENTIAL PRESSURE—HIGH OVERPRESSURE CAPACITY

## STANDARD AND METRIC MODELS

0-30 to 0-5000 psi-Standard Models

0-2 to 0-350 bar-Metric Models

Differential Pressure

mV/V Output

0 to 5 Vdc Output

4 to 20 mA Output

1 bar = 14.5 psi

1 kg/cm<sup>2</sup> = 14.22 psi

1 atmosphere = 14.7 psi = 29.93

inHg = 760.2 mmHg = 1.014 bar

### PX80/PXM80 Series



- ✓ Low Differential Pressure at High Line Pressure—1500 psi (100 bar) Standard
- ✓ All Stainless Steel Construction
- ✓ Sealed for Harsh Environments
- ✓ Rugged Lightning-Protected Housing Available, Style 5

OMEGA's PX80/PXM80 is a heavy-duty, wet/wet, differential pressure transducer that comes in ranges of 0-30 to 0-5000 psi (0-2 to 0-350 bar). Models are available in any of 3 outputs: mV/V, amplified 0 to 5 Vdc, or 4 to 20 mA. All are suitable for interface with most PLCs and computer-based control systems. An extremely high overpressure capacity of 1500 psi or 150% of capacity (whichever is greater) makes the PX80/PXM80 an extremely durable transducer. The all stainless steel construction and high overpressure protection offer high reliability in harsh industrial environments.



DIFFERENTIAL PRESSURE TRANSDUCERS **B**

# DIFFERENTIAL PRESSURE TRANSDUCERS

Style 5 sealed metal terminal box most ranges, visit us online.

## SPECIFICATIONS

### mV/V Output

#### Electrical:

**Excitation:** 10 Vdc (15 V maximum)

**Output:** 2 mV/V nominal

**Bridge Resistance:** 350 Ω

**Zero Balance:** ±1% FSO

### 5 Vdc Output

#### Electrical:

**Excitation:** 24 to 32 Vdc

**Output:** 0 to 5 Vdc ±10% adj

**Zero Balance:** 0 V ±10% adj

### 4 to 20 mA Output

#### Electrical:

**Excitation:** 10 to 40 Vdc

**Output:** 4 to 20 mA ±0.8 mA adj

### Max Loop Resistance:

(Input voltage – 12) x 50

**Zero Balance:** 4 mA ± 0.4 mA adj

## COMMON SPECIFICATIONS

### Performance:

**Linearity:** ±0.25% FSO

**Hysteresis:** ±0.10% FSO

**Repeatability:** ±0.1% FSO

### Operating Temp Range:

**mV/V:** -73 to 163°C (-100 to 325°F)

**Amplified:** -46 to 107°C

(-50 to 225°F)

### Compensated Temp Range:

**mV/V:** 17 to 71°C (60 to 160°F)

### Thermal Effects:

**Zero:** 0.009% FSO/°C

(mV and 5V)

**Zero:** 0.013% FSO/°C (4 to 20 mA)

**Span:** 0.009% rdg/°C

### Pressure:

**Line Pressure:** 1500 psi (100 bar) or 150% of rated pressure, whichever is greater

**Burst Pressure:** 6000 psi (414 bar) minimum

**Wetted Parts:** 17-4 PH stainless steel and Buna-N O-ring

**Pressure Port:** See dimensional drawings on following pages

### Electrical Termination:

**Style 0** = 3 m (10') cable

**Style 1** = PTIH-10-6P (or equiv)

**Style 5** = Metal terminal box (4 to 20 mA output models only)

**Style 6** = mini DIN

### Mating Connector:

**Style 1:** PT06F10-6S

(sold separately)

**Style 6:** Mating connector

(included)

**Weight:** 5 lb



**STANDARD**  
PX80D5-050DI  
shown smaller than  
actual size.

## STANDARD AND METRIC CUSTOM CONFIGURATIONS

### MODEL NUMBER SPECIFICATION:

# PXM80D0-100DV

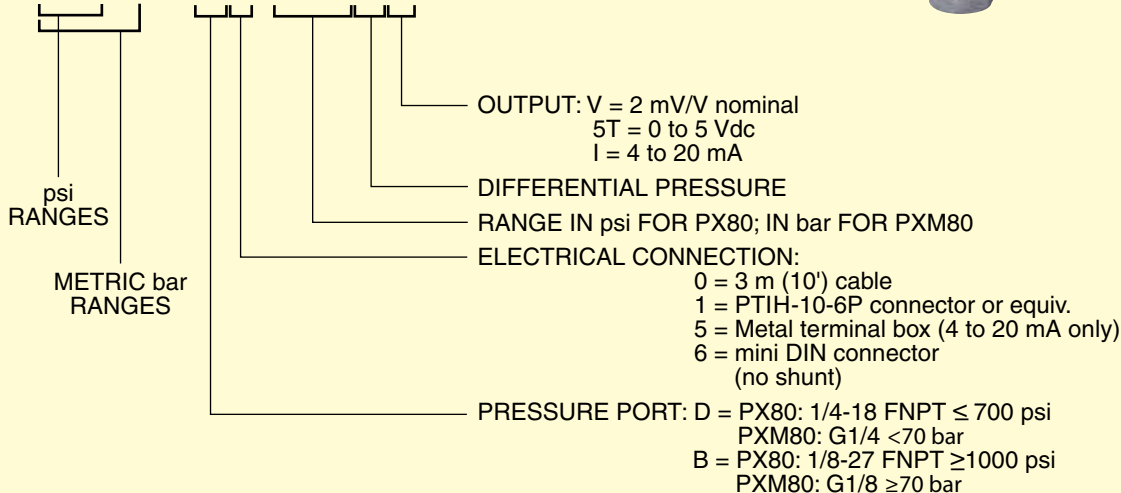

To order extra cable on cable style models, add suffix “-(length in feet)FT” and add cost/ft beyond the standard 3 m (10') length.

**Ordering Examples:** PX80B5-1KDI, 1000 psid range model with 4 to 20 mA output and a lightning-protected amplifier housing  
PX80D0-030DI-25FT, 30 psid range model, 4 to 20 mA output and 7.6m (25') cable.

PX80D1-200DV, 200 psid range model with mV/V output and twist-lock connector. PT06F10-6S, mating connector (sold separately).

# mV/V OUTPUT STANDARD RANGES

**mV/V Output**  
**0-30 to 0-5000 psi**  
**(0-2 to 0-350 bar)**  
**Differential Pressure**

## PX80 Series mV Models



- ✓ Low Differential Pressure at High Line Pressure—1500 psi Standard
- ✓ All Stainless Steel Construction
- ✓ Sealed for Harsh Environments
- ✓ High Overpressure

### CONNECTIONS mV/V

	PIN	Cable	DIN
+Output	A	Green	2
-Output	B	White	3
-Input	C	Black	GRND
+Input	D	Red	1
Shunt	E	Blue	
Shunt	F	Orange	

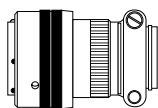

**Style 1 Mating Connector**  
**PT06F10-6S**  
 sold separately.

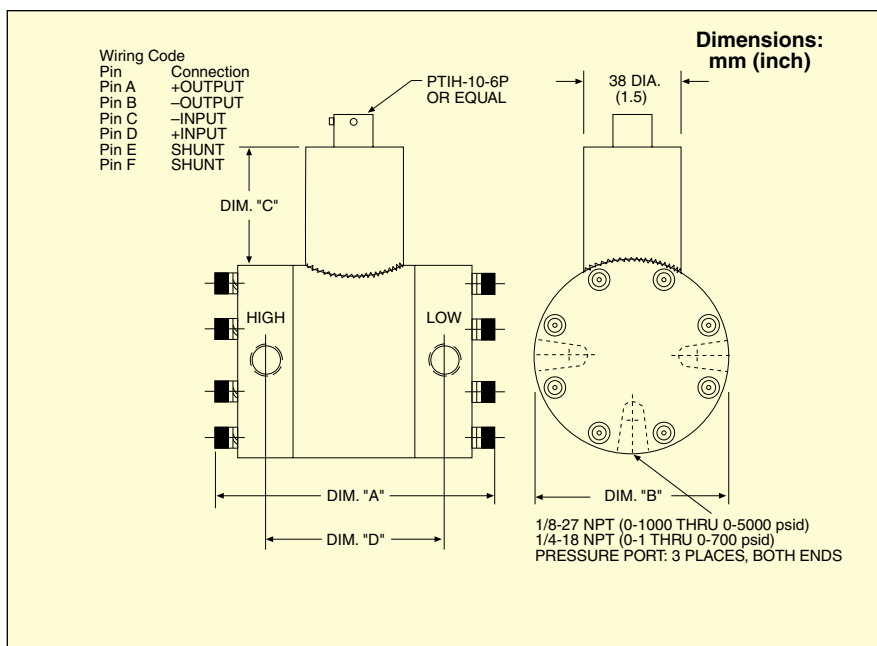

**Dimensions: mm (inch)**

Capacity	A	B	C	D
<1000 psi	111 (4.38)	76 (3.0)	49 (1.94)	75 (2.94)
≥1000 psi	76 (3.0) + Fitting	51 (2.0)	54 (2.13)	N/A

### STANDARD MODELS

To Order			
Models with mV Output and Integral Connector			
RANGE		MODEL NO.	COMPATIBLE METERS*
0 to 30 psid	0 to 2.1 bar	PX80D[*]-030DV	DP41-S, DP25B-S
0 to 50 psid	0 to 3.4 bar	PX80D[*]-050DV	DP41-S, DP25B-S
0 to 100 psid	0 to 6.9 bar	PX80D[*]-100DV	DP41-S, DP25B-S
0 to 200 psid	0 to 13.8 bar	PX80D[*]-200DV	DP41-S, DP25B-S
0 to 300 psid	0 to 20.7 bar	PX80D[*]-300DV	DP41-S, DP25B-S
0 to 500 psid	0 to 34.5 bar	PX80D[*]-500DV	DP41-S, DP25B-S
0 to 700 psid	0 to 48.3 bar	PX80D[*]-700DV	DP41-S, DP25B-S
0 to 1000 psid	0 to 68.9 bar	PX80B[*]-1KDV	DP41-S, DP25B-S
0 to 1500 psid	0 to 103 bar	PX80B[*]-1.5KDV	DP41-S, DP25B-S
0 to 2000 psid	0 to 138 bar	PX80B[*]-2KDV	DP41-S, DP25B-S
0 to 2500 psid	0 to 172 bar	PX80B[*]-2.5KDV	DP41-S, DP25B-S
0 to 3000 psid	0 to 207 bar	PX80B[*]-3KDV	DP41-S, DP25B-S
0 to 5000 psid	0 to 345 bar	PX80B[*]-5KDV	DP41-S, DP25B-S

Comes complete with 5-point NIST traceable calibration.

\* Visit us online for compatible meters.

[\*] Insert "0" for 3 m (10') cable, "1" for twist-lock connector, or "6" for mini DIN connector.

**Ordering Examples:** PX80D1-030DV, ±30 psid range differential transducer with 1/4-18 NPT pressure fittings, twist-lock electrical connector and mV/V output. PT06F10-6S, mating connector (sold separately).

PX80B1-1KDV, ±1000 psid range differential transducer with 1/8-27 NPT pressure fittings, twist-lock electrical connector and mV/V output.

# mV/V OUTPUT METRIC RANGES

**mV/V Output**  
**0-2 to 0-350 bar**  
**0-30 to 0-5000 psi**  
**Differential Pressure**

## PXM80 Series mV Models

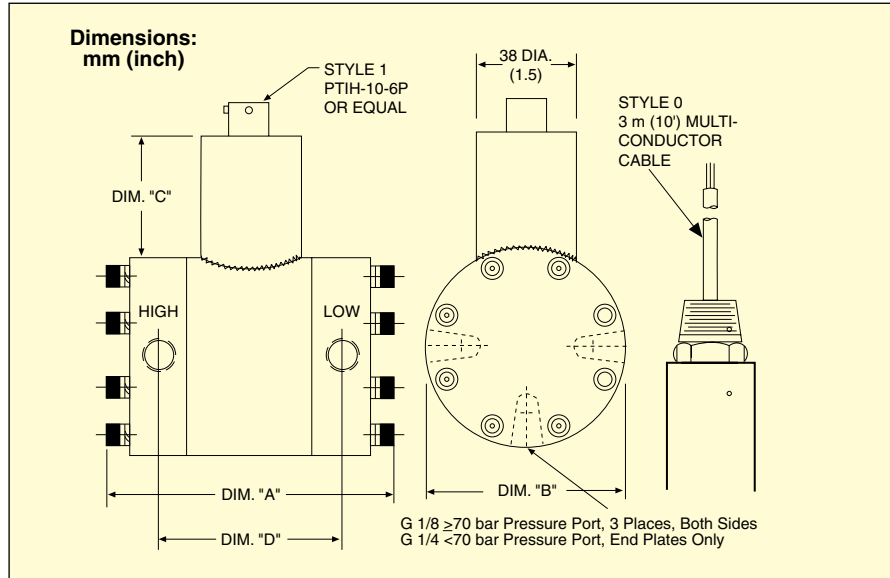

Dimensions: mm (inch)

CAPACITY	A	B	C	D
<70 bar	111 (4.38)	76 (3.0)	49 (1.94)	75 (2.94)
$\geq$ 70 bar	76 (3.0) + fitting	51 (2.0)	54 (2.13)	N/A

- ✓ Low Differential Pressure at High Line Pressure—100 bar Standard
- ✓ All Stainless Steel Construction
- ✓ Sealed for Harsh Environments
- ✓ High Overpressure

### METRIC MODELS

#### To Order

Models with mV/V Output, Specify Electrical Termination

RANGE	MODEL NO.	COMPATIBLE METERS*
<b>DIFFERENTIAL PRESSURE</b>		
0 to 2 bar	0 to 29 psi	PXM80MD[*]-002BARDV
0 to 3.50 bar	0 to 51 psi	PXM80MD[*]-3.50BARDV
0 to 7 bar	0 to 102 psi	PXM80MD[*]-007BARDV
0 to 14 bar	0 to 203 psi	PXM80MD[*]-014BARDV
0 to 20 bar	0 to 290 psi	PXM80MD[*]-020BARDV
0 to 35 bar	0 to 508 psi	PXM80MD[*]-035BARDV
0 to 50 bar	0 to 725 psi	PXM80MD[*]-050BARDV
0 to 70 bar	0 to 1015 psi	PXM80MB[*]-070BARDV
0 to 100 bar	0 to 1450 psi	PXM80MB[*]-100BARDV
0 to 140 bar	0 to 2031 psi	PXM80MB[*]-140BARDV
0 to 175 bar	0 to 2538 psi	PXM80MB[*]-175BARDV
0 to 200 bar	0 to 2901 psi	PXM80MB[*]-200BARDV
0 to 350 bar	0 to 5076 psi	PXM80MB[*]-350BARDV

Comes complete with 5-point NIST traceable calibration.

[\*] Insert "0" for 3 m (10') cable, "1" for twist-lock connector or "6" for mini DIN connector

\* Visit us online for compatible meters.

To order extra cable on cable style models, add suffix "(total length in meters)M" and add cost/m beyond the standard 3 m (10') length.

Ordering Examples: PXM80MD0-002BARDV-10M, 2 bar range differential transducer with G 1/4 female pressure fittings, 10 m (32') cable and mV/V output. PXM80MB1-100BARDV, 100 bar range differential transducer with G 1/8 pressure fittings, twist-lock electrical connector and mV/V output. PT06F10-6S, mating connector (sold separately).

#### CONNECTIONS mV/V

	PIN	Cable	DIN
+Output	A	Green	2
-Output	B	White	3
-Input	C	Black	GRND
+Input	D	Red	1
Shunt	E	Blue	
Shunt	F	Orange	

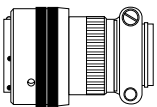

Style 1 Mating Connector  
PT06F10-6S  
sold separately.



# 0 to 5 Vdc OUTPUT STANDARD RANGES

**0 to 5 Vdc Output**  
**0-30 to 0-5000 psi**  
**(0-2 bar to 0-350 bar)**  
**Differential Pressure**

## PX80 Series

5V Models



- ✓ Low Differential Pressure at High Line Pressure—1500 psi Standard
- ✓ All Stainless Steel Construction
- ✓ Sealed for Harsh Environments
- ✓ High Overpressure

**STANDARD**  
 PX80B1-2KD5T  
 shown smaller than actual size.

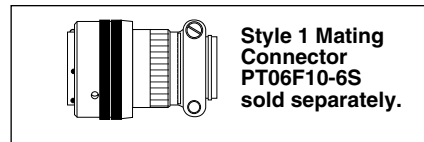
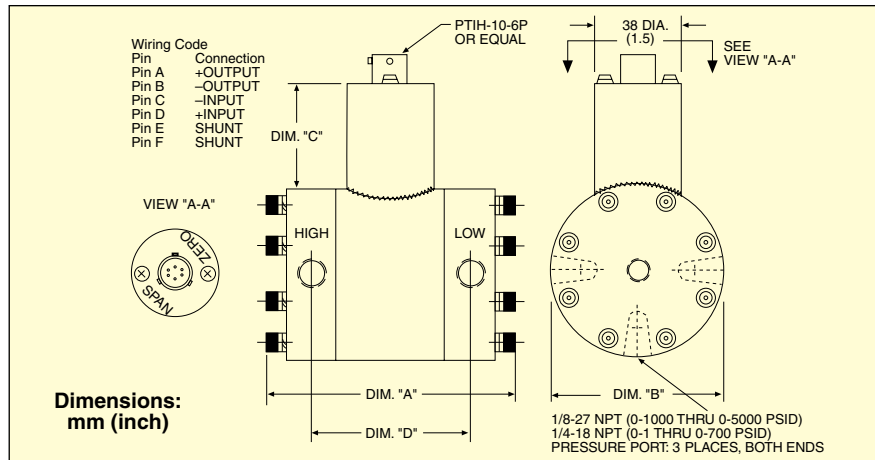

CONNECTIONS 5 Vdc			
	PIN	Cable	DIN
+Output	A	Green	2
-Output	B	White	3
-Input	C	Black	GRND
+Input	D	Red	1
Shunt	E	Blue	
Shunt	F	Orange	

Dimensions: mm (inch)

CAPACITY	A	B	C	D
<1000 psi	111 (4.38)	76 (3.0)	62 (2.44)	75 (2.94)
≥1000 psi	76 (3.0) + Fitting	51 (2.0)	76 (3.0)	N/A

### STANDARD MODELS

To Order			
Models with 0 to 5 V Output and Integral Connector			
RANGE		MODEL NO.	COMPATIBLE METERS*
0 to 30 psid	0 to 2 bar	PX80D[*]-030D5T	DP41-E, DP25B-E, DP24-E
0 to 50 psid	0 to 3.4 bar	PX80D[*]-050D5T	DP41-E, DP25B-E, DP24-E
0 to 100 psid	0 to 6.9 bar	PX80D[*]-100D5T	DP41-E, DP25B-E, DP24-E
0 to 200 psid	0 to 13.8 bar	PX80D[*]-200D5T	DP41-E, DP25B-E, DP24-E
0 to 300 psid	0 to 20.7 bar	PX80D[*]-300D5T	DP41-E, DP25B-E, DP24-E
0 to 500 psid	0 to 34.5 bar	PX80D[*]-500D5T	DP41-E, DP25B-E, DP24-E
0 to 700 psid	0 to 48.3 bar	PX80D[*]-700D5T	DP41-E, DP25B-E, DP24-E
0 to 1000 psid	0 to 68.9 bar	PX80B[*]-1KD5T	DP41-E, DP25B-E, DP24-E
0 to 1500 psid	0 to 103 bar	PX80B[*]-1.5KD5T	DP41-E, DP25B-E, DP24-E
0 to 2000 psid	0 to 138 bar	PX80B[*]-2KD5T	DP41-E, DP25B-E, DP24-E
0 to 2500 psid	0 to 172 bar	PX80B[*]-2.5KD5T	DP41-E, DP25B-E, DP24-E
0 to 3000 psid	0 to 207 bar	PX80B[*]-3KD5T	DP41-E, DP25B-E, DP24-E
0 to 5000 psid	0 to 345 bar	PX80B[*]-5KD5T	DP41-E, DP25B-E, DP24-E

Comes complete with 5-point NIST traceable calibration.

\* Visit us online for compatible meters.

[\*] Insert "0" for 3 m (10') cable, "1" for twist-lock connector, or "6" for mini DIN connector.

**Ordering Examples:** PX80D1-050D5T, 50 psid range differential transducer with 0 to 5 Vdc output, 1/4-18 NPT pressure fittings, and twist-lock electrical connector. PT06F10-6S, mating connector (sold separately). PX80B0-1KD5T, 1000 psid range differential transducer with 0 to 5 Vdc output, 1/8-27 NPT pressure fittings, and 3 m (10') PVC cable.

# 0 to 5 Vdc OUTPUT METRIC RANGES

**0 to 5 Vdc Output**  
**0-2 to 0-350 bar**  
**0-30 to 0-5000 psi**  
**Differential Pressure**

## PXM80 Series

5V Models



- ✓ Low Differential Pressure at High Line Pressure—100 bar Standard
- ✓ All Stainless Steel Construction
- ✓ Sealed for Harsh Environments
- ✓ High Overpressure

**METRIC**  
 PXM80MD1-007BARD5T  
 shown smaller than actual size.

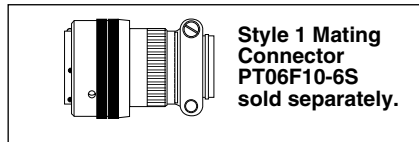
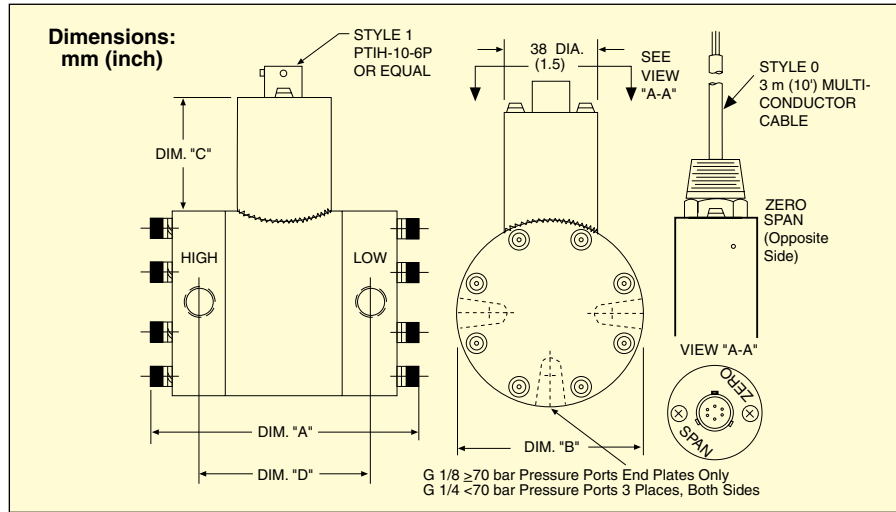

CONNECTIONS 5 Vdc			
	PIN	Cable	DIN
+Output	A	Green	2
-Output	B	White	3
-Input	C	Black	GRND
+Input	D	Red	1
Shunt	E	Blue	
Shunt	F	Orange	

**Dimensions: mm (inch)**

CAPACITY	A	B	C	D
<70 bar	111 (4.38)	76 (3.0)	62 (2.44)	75 (2.94)
≥70 bar	76 (3.0) + fitting	51 (2.0)	76 (3.0)	N/A

### METRIC MODELS

#### To Order

Models with 0 to 5 V Output, Specify Electrical Termination

RANGE	MODEL NO.	COMPATIBLE METERS*
<b>DIFFERENTIAL PRESSURE</b>		
0 to 2 bar	0 to 29 psi	PXM80MD[*]-002BARD5T DP41-E, DP25B-E, DP24-E
0 to 3.50 bar	0 to 51 psi	PXM80MD[*]-3.50BARD5T DP41-E, DP25B-E, DP24-E
0 to 7 bar	0 to 102 psi	PXM80MD[*]-007BARD5T DP41-E, DP25B-E, DP24-E
0 to 14 bar	0 to 203 psi	PXM80MD[*]-014BARD5T DP41-E, DP25B-E, DP24-E
0 to 20 bar	0 to 290 psi	PXM80MD[*]-020BARD5T DP41-E, DP25B-E, DP24-E
0 to 35 bar	0 to 508 psi	PXM80MD[*]-035BARD5T DP41-E, DP25B-E, DP24-E
0 to 50 bar	0 to 725 psi	PXM80MD[*]-050BARD5T DP41-E, DP25B-E, DP24-E
0 to 70 bar	0 to 1015 psi	PXM80MB[*]-070BARD5T DP41-E, DP25B-E, DP24-E
0 to 100 bar	0 to 1450 psi	PXM80MB[*]-100BARD5T DP41-E, DP25B-E, DP24-E
0 to 140 bar	0 to 2031 psi	PXM80MB[*]-140BARD5T DP41-E, DP25B-E, DP24-E
0 to 175 bar	0 to 2538 psi	PXM80MB[*]-175BARD5T DP41-E, DP25B-E, DP24-E
0 to 200 bar	0 to 2901 psi	PXM80MB[*]-200BARD5T DP41-E, DP25B-E, DP24-E
0 to 350 bar	0 to 5076 psi	PXM80MB[*]-350BARD5T DP41-E, DP25B-E, DP24-E

Comes complete with 5-point NIST traceable calibration. \* Visit us online for compatible meters. [\*] Insert "0" for 3 m (10') cable, "1" for twist-lock connector or "6" for mini DIN connector. To order extra cable on cable style models, add suffix "-(Total length in meters)M" and add cost/m beyond the standard 3 m (10') length.

**Ordering Examples:** PXM80MD0-002BARD5T-10M, 2 bar range differential transmitter with G 1/4 female pressure fittings, 10 m (32') cable and 0 to 5 Vdc output.

PXM80MB1-100BARD5T, 100 bar range differential transmitter with G 1/8 pressure fittings, twist-lock electrical connector and 0 to 5 Vdc output.  
 PT06F10-6S, mating connector (sold separately).

# 4 to 20 mA OUTPUT STANDARD RANGES

**4 to 20 mA Output**  
**0-30 to 0-5000 psid**  
**(0-2 bar to 0-350 bar)**  
**Differential Pressure**

## PX80 Series

4 to 20 mA Models



- ✓ Low Differential Pressure at High Line Pressure—1500 psi Standard
- ✓ All Stainless Steel Construction
- ✓ Sealed for Harsh Environments
- ✓ High Overpressure



STANDARD PX80DI-100DI shown smaller than actual size.

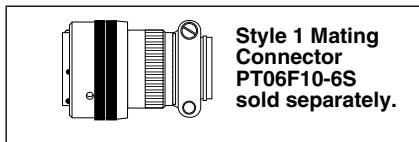
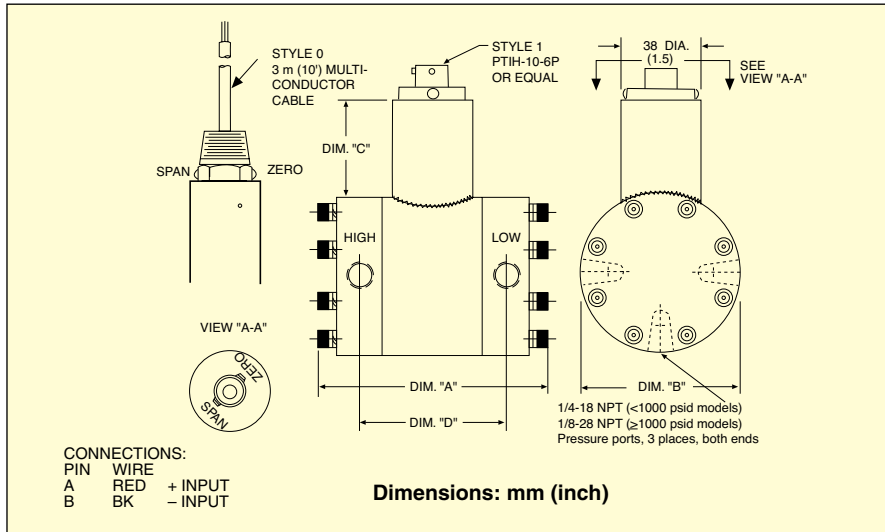

CONNECTIONS 4 to 20 mA			
	PIN	Cable	DIN
+ Input	A	Red	1
- Input	B	Black	2

Dimensions: mm (inch)

CAPACITY	A	B	C	D
<1000 psi	111 (4.38)	75 (2.94)	62 (2.44)	76 (3.0)
≥1000 psi	76 (3.0) + fitting	51 (2.0)	76 (3.0)	N/A

### STANDARD MODELS

To Order			
Models with 4 to 20 mA Output			
RANGE psid	RANGE bar	MODEL NO.	COMPATIBLE METERS*
0 to 30	0 to 2	PX80D[*]-030DI	DP41-E, DP25B-E, DP24-E
0 to 50	0 to 3.4	PX80D[*]-050DI	DP41-E, DP25B-E, DP24-E
0 to 100	0 to 6.9	PX80D[*]-100DI	DP41-E, DP25B-E, DP24-E
0 to 200	0 to 13.8	PX80D[*]-200DI	DP41-E, DP25B-E, DP24-E
0 to 300	0 to 20.7	PX80D[*]-300DI	DP41-E, DP25B-E, DP24-E
0 to 500	0 to 34.5	PX80D[*]-500DI	DP41-E, DP25B-E, DP24-E
0 to 700	0 to 48.3	PX80D[*]-700DI	DP41-E, DP25B-E, DP24-E
0 to 1000	0 to 68.9	PX80B[*]-1KDI	DP41-E, DP25B-E, DP24-E
0 to 1500	0 to 103	PX80B[*]-1.5KDI	DP41-E, DP25B-E, DP24-E
0 to 2000	0 to 138	PX80B[*]-2KDI	DP41-E, DP25B-E, DP24-E
0 to 2500	0 to 172	PX80B[*]-2.5KDI	DP41-E, DP25B-E, DP24-E
0 to 3000	0 to 207	PX80B[*]-3KDI	DP41-E, DP25B-E, DP24-E
0 to 5000	0 to 345	PX80B[*]-5KDI	DP41-E, DP25B-E, DP24-E

Comes complete with 5-point NIST traceable calibration.

\* Visit us online for compatible meters.

[\*] Insert "0" for 3 m (10') cable, "1" for twist-lock connector, or "6" for mini DIN connector.

To order extra cable length, add suffix "(Length in feet)FT" to model number and add cost/ft beyond standard 3 m (10') length.

Ordering Examples: PX80D0-050DI-25FT, 50 psid differential transmitter with 7.6 m (25') cable and 1/4-18 NPT fitting. PX80B0-1.5KDI, 1500 psid differential transmitter with 3 m (10') cable, and 1/2-27 NPT fitting.

# 4 to 20 mA OUTPUT **METRIC** RANGES

**4 to 20 mA Output**  
**0-2 to 0-350 bar**  
**0-30 to 0-5000 psi**  
**Differential Pressure**

**PXM80 Series**  
**4 to 20 mA Models**



- ✓ Low Differential Pressure at High Line Pressure—100 bar Standard
- ✓ All Stainless Steel Construction
- ✓ Sealed for Harsh Environments
- ✓ High Overpressure

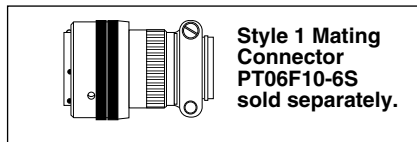
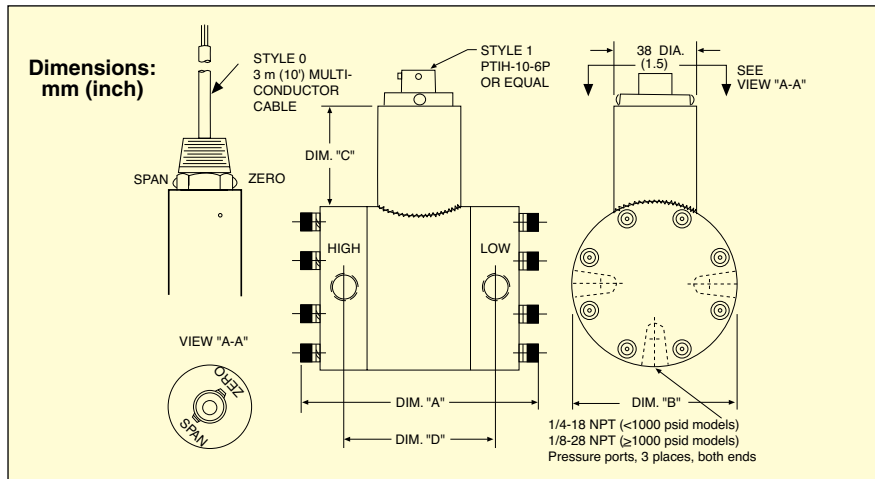

### CONNECTIONS 4 to 20 mA

	PIN	Cable	DIN
+ Input	A	Red	1
- Input	B	Black	2

Dimensions: mm (inch)

CAPACITY	A	B	C	D
<70 bar	111 (4.38)	75 (2.94)	62 (2.44)	76 (3.0)
≥70 bar	76 (3.0) + fitting	51 (2.0)	76 (3.0)	N/A

### METRIC MODELS

To Order			
Models with 4 to 20 mA Output, Specify Electrical Termination			
RANGE	MODEL NO.	COMPATIBLE METERS*	
<b>DIFFERENTIAL PRESSURE</b>			
0 to 2 bar	0 to 29 psi	<b>PXM80MD[*]-002BARDI</b>	DP41-E, DP25B-E, DP24-E
0 to 3.50 bar	0 to 51 psi	<b>PXM80MD[*]-3.50BARDI</b>	DP41-E, DP25B-E, DP24-E
0 to 7 bar	0 to 102 psi	<b>PXM80MD[*]-007BARDI</b>	DP41-E, DP25B-E, DP24-E
0 to 14 bar	0 to 203 psi	<b>PXM80MD[*]-014BARDI</b>	DP41-E, DP25B-E, DP24-E
0 to 20 bar	0 to 290 psi	<b>PXM80MD[*]-020BARDI</b>	DP41-E, DP25B-E, DP24-E
0 to 35 bar	0 to 508 psi	<b>PXM80MD[*]-035BARDI</b>	DP41-E, DP25B-E, DP24-E
0 to 50 bar	0 to 725 psi	<b>PXM80MD[*]-050BARDI</b>	DP41-E, DP25B-E, DP24-E
0 to 70 bar	0 to 1015 psi	<b>PXM80MB[*]-070BARDI</b>	DP41-E, DP25B-E, DP24-E
0 to 100 bar	0 to 1450 psi	<b>PXM80MB[*]-100BARDI</b>	DP41-E, DP25B-E, DP24-E
0 to 140 bar	0 to 2031 psi	<b>PXM80MB[*]-140BARDI</b>	DP41-E, DP25B-E, DP24-E
0 to 175 bar	0 to 2538 psi	<b>PXM80MB[*]-175BARDI</b>	DP41-E, DP25B-E, DP24-E
0 to 200 bar	0 to 2901 psi	<b>PXM80MB[*]-200BARDI</b>	DP41-E, DP25B-E, DP24-E
0 to 350 bar	0 to 5076 psi	<b>PXM80MB[*]-350BARDI</b>	DP41-E, DP25B-E, DP24-E

Comes complete with 5-point NIST traceable calibration. \* Visit us online for compatible meters

[\*] Insert "0" for 3 m (10') cable, "1" for twist-lock connector, "5" for metal terminal box or "6" for mini DIN connector. To order extra cable on cable style models, add suffix "-(total length in meters)M" and add cost/m beyond the standard 3 m (10') length.

**Ordering Examples:** **PXM80MD0-002BARDI-10M**, 2 bar range differential transmitter with G 1/4 female pressure fittings, 10 m (32') cable and 4 to 20 mA output.  
**PXM80MB1-100BARDI**, 100 bar range differential transmitter with G 1/8 pressure fittings, twist-lock electrical connector and 4 to 20 mA output. **PT06F10-6S**, mating connector (sold separately).