

MICRO-MACHINED SILICON TRANSDUCERS

WET/DRY DIFFERENTIAL PRESSURE MODELS

mV/V, 0 to 5 or 0 to 10 Vdc, or 4 to 20 mA Outputs
Uni-Directional Ranges
0-10 inH₂O to 0-1000 psid



PX409 Series

- 5-Point NIST Traceable Calibration
- Precision Micro-Machined Silicon Core
- High Stability, Low Drift
- Welded Stainless Steel Construction
- 316L SS Wetted Parts on Wet Side—Clean Dry Gases in Dry Side
- Digital Dynamic Thermal Compensation Across Temperature and Pressure Range
- Premium Temperature Performance
- Broad Compensated Temperature Range
- Durable, 1 Million Cycle Life
- Ruggedized with Secondary Containment
- Customized Specifications Available

These rugged stainless steel transducers are ideal for industrial, automotive, or aerospace applications where only one side of the transducer is exposed to wet media. These wet/dry transducers deliver the great performance characteristics of the Micro-Machined Silicon Series Transducers at a lower price than the wet/wet models. They can be used in test benches, filter monitoring, air flow, factory or pneumatic air, pitot tubes, air speed and other industrial or aerospace applications requiring a very rugged wet/dry transducer. The solid state silicon core will provide long, reliable service life with excellent long term stability. To obtain their high accuracy and stability, the PX409 Series use state of the art digital mapping of the temperature, pressure and output performance of the silicon sensor in conjunction with a custom ASIC to provide dynamic thermal compensation across the temperature and pressure parameters.

COMMON SPECIFICATIONS

Accuracy: 0.08% BSL linearity, hysteresis and repeatability combined

Minimum Resistance Between Transducer Body and Any Wire: 100 MΩ

Operating Temperature:

mV/V and 5 to 10 Vdc Output: -45 to 121°C (-49 to 250°F)
mA Output: -45 to 115°C (-49 to 239°F)

Compensated Temperature Range:

10 inH₂O to 5 psi: -17 to 85°C (1 to 185°F)
15 to 1000 psi: -29 to 85°C (-20 to 185°F)

Thermal Accuracy: **Zero** **Span**
 % Span Shift over compensated temperature range

10 inH₂O to 5 psi: ±1.00% ±1.00%
15 to 1000 psi: ±0.50% ±0.50%

Pressure Cycles: 1 million minimum

Long Term Stability (1-Year): ±0.1% FS typical

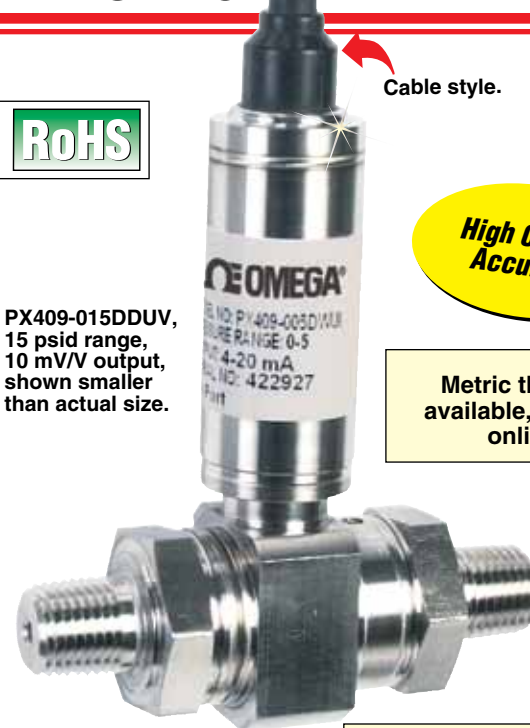

Cable style.

High 0.08% Accuracy

Metric threads available, visit us online

PX409-015DDUV, 15 psid range, 10 mV/V output, shown smaller than actual size.

Fast Delivery! Stock to 2 Weeks On Most Models

Five Electrical Termination Styles



PX459, M12 connector



PX409, 2 m (6') cable.



PX419, mini DIN.



PX409C, conduit cable.



PX429, twist-lock.

DIFFERENTIAL PRESSURE TRANSDUCERS **B**

MICRO-MACHINED SILICON TRANSDUCERS WET/DRY DIFFERENTIAL PRESSURE MODELS

Bandwidth: DC to 1 kHz typical

Response Time: <1 ms

CE Compliant: Meets EN61326-1: 2006 for industrial locations

Shock: 50 g, 11 mS half sine, vertical and horizontal axis

Vibration: 5-2000-5 Hz, 30 minute cycle, Curve L, Mil-Spec 810 figure 514-2-2, vertical and horizontal axis

Media Compatibility:

High Side: All fluids and gases compatible with 316L SS

Low Side: Clean, dry, non-ionic gases

Line/Static Pressure: 500 psi maximum applied to both sides simultaneously

Proof Pressure (Differential):

10 inH₂O range = 10 times range

1 psi range = 6 times range

2.5 to 750 psi ranges = 4 times range

1000 psi range = 3 times range

Hi Side Containment Pressure (Differential):

Ranges 10 inH₂O to 5 psi: to 1000 psi

Ranges 15 to 1000 psi: to 3000 psi

Pressure Ports: ¼ NPT male

Electrical Terminations:

PX409: 2 m (6') cable

PX409C: 2 m (6') cable with ½ NPT conduit thread

PX419: mini DIN (mating connector included)

PX429: Twist-lock (mating connector sold separately)

PX429 Mating Connector: PT06F10-6S

PX459: M12 connector

Weight: 200 g (7 oz) maximum

Dimensions: mm (inch)

Conduit backend PX409C

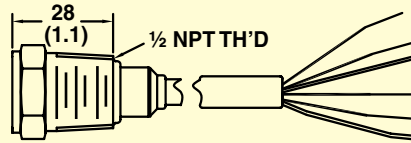

Integral cable backend PX409

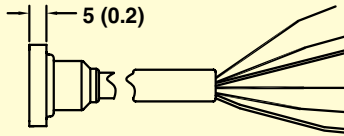

Twist-lock backend PX429

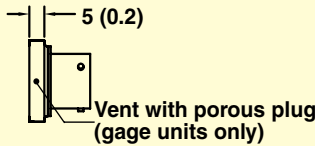

mini DIN backend PX419

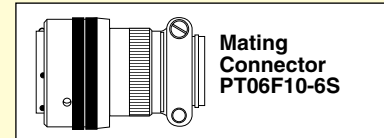
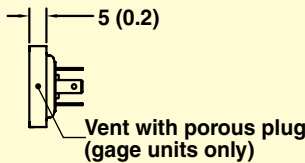

M12 connector backend PX459
Ø 20.2 (0.8)

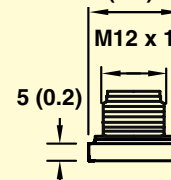

Dimensions: mm (inch)
ø = diameter

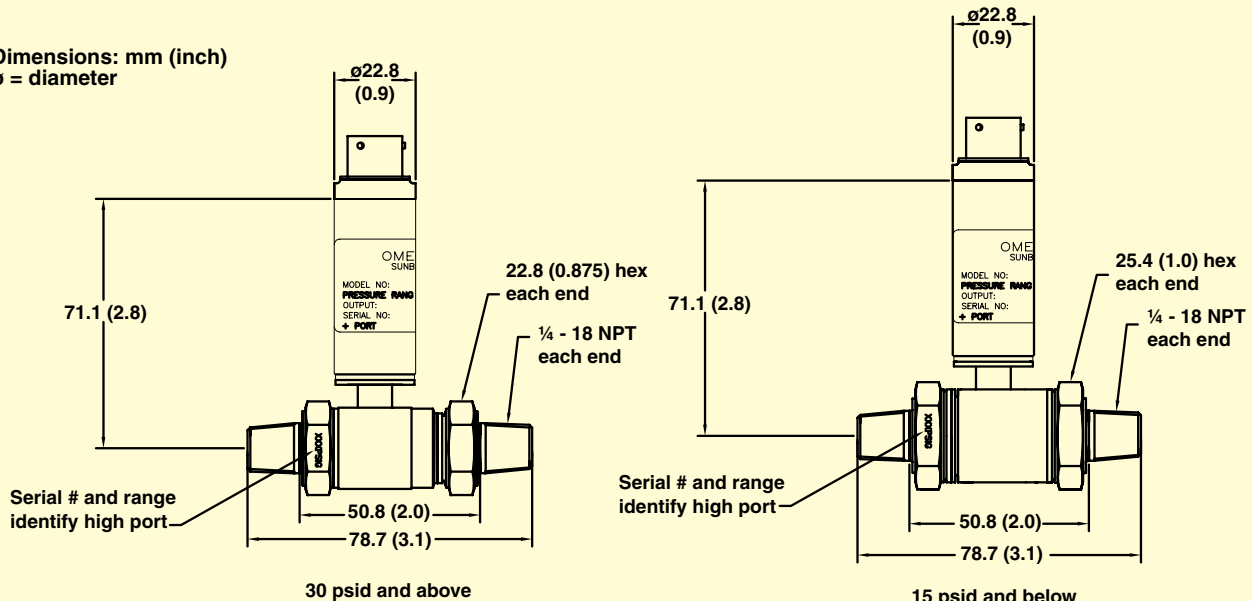

WET/DRY DIFFERENTIAL PRESSURE MODELS

UNI-DIRECTIONAL RANGES WITH mV/V OUTPUTS

UNI-DIRECTIONAL mV/V SPECIFICATIONS

- Output: 10 mV/V ratiometric
- Supply Voltage: 5 to 10 Vdc
- Current Draw: 5 mA @ 10 Vdc
- Input Impedance: 1000 to 5000 Ω
- Output Impedance: 5000 Ω \pm 10% typical
- Zero Balance:
 - Ranges \leq 2.5psi: \pm 1% typical (2% maximum)
 - Ranges $>$ 2.5psi: \pm 0.5% typical (1% maximum)
- Span Setting:
 - Ranges \leq 2.5psi: \pm 1% typical (2% maximum)
 - Ranges $>$ 2.5psi: \pm 0.5% typical (1% maximum)

CABLE TERMINATION*

To Order

10 mV/V OUTPUT, 1/4 NPT MALE FITTINGS

RANGE	METRIC	MODEL NO.
0 to 10 inH ₂ O	25 mbar	PX409-10WDDUV
0 to 1 psi	70 mbar	PX409-001DDUV
0 to 2.5 psi	170 mbar	PX409-2.5DDUV
0 to 5 psi	350 mbar	PX409-005DDUV
0 to 15 psi	1 bar	PX409-015DDUV
0 to 30 psi	2 bar	PX409-030DDUV
0 to 50 psi	3.5 bar	PX409-050DDUV
0 to 100 psi	7 bar	PX409-100DDUV
0 to 150 psi	10 bar	PX409-150DDUV
0 to 250 psi	17.5 bar	PX409-250DDUV
0 to 500 psi	35 bar	PX409-500DDUV
0 to 750 psi	50 bar	PX409-750DDUV
0 to 1000 psi	70 bar	PX409-1.0KDDUV

* To order conduit fitting backend change model number from "PX409" to "PX409C", no additional cost.

MINI DIN TERMINATION

10 mV/V OUTPUT, 1/4 NPT MALE FITTINGS

RANGE	METRIC	MODEL NO.
0 to 10 inH ₂ O	25 mbar	PX419-10WDDUV
0 to 1 psi	70 mbar	PX419-001DDUV
0 to 2.5 psi	170 mbar	PX419-2.5DDUV
0 to 5 psi	350 mbar	PX419-005DDUV
0 to 15 psi	1 bar	PX419-015DDUV
0 to 30 psi	2 bar	PX419-030DDUV
0 to 50 psi	3.5 bar	PX419-050DDUV
0 to 100 psi	7 bar	PX419-100DDUV
0 to 150 psi	10 bar	PX419-150DDUV
0 to 250 psi	17.5 bar	PX419-250DDUV
0 to 500 psi	35 bar	PX419-500DDUV
0 to 750 psi	50 bar	PX419-750DDUV
0 to 1000 psi	70 bar	PX419-1.0KDDUV

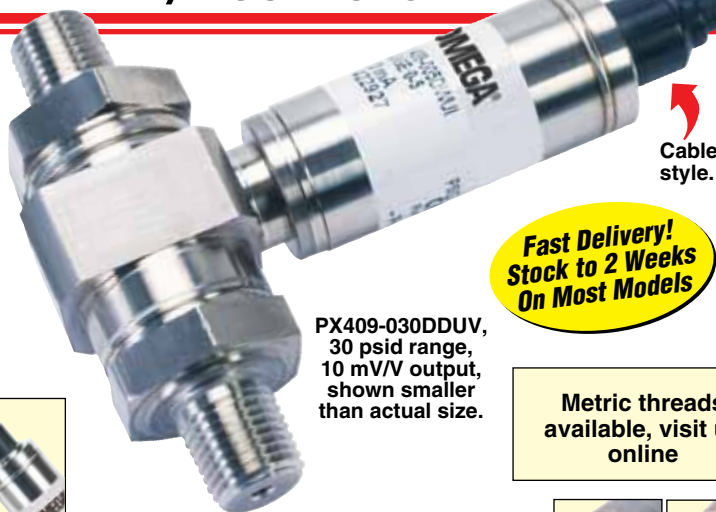

Fast Delivery!
Stock to 2 Weeks
On Most Models

PX409-030DDUV,
30 psid range,
10 mV/V output,
shown smaller
than actual size.

Metric threads
available, visit us
online



M12 or TWIST-LOCK TERMINATION

10 mV/V OUTPUT, 1/4 NPT MALE FITTINGS

RANGE	METRIC	MODEL NO.
0 to 10 inH ₂ O	25 mbar	PX4[*]9-10WDDUV
0 to 1 psi	70 mbar	PX4[*]9-001DDUV
0 to 2.5 psi	170 mbar	PX4[*]9-2.5DDUV
0 to 5 psi	350 mbar	PX4[*]9-005DDUV
0 to 15 psi	1 bar	PX4[*]9-015DDUV
0 to 30 psi	2 bar	PX4[*]9-030DDUV
0 to 50 psi	3.5 bar	PX4[*]9-050DDUV
0 to 100 psi	7 bar	PX4[*]9-100DDUV
0 to 150 psi	10 bar	PX4[*]9-150DDUV
0 to 250 psi	17.5 bar	PX4[*]9-250DDUV
0 to 500 psi	35 bar	PX4[*]9-500DDUV
0 to 750 psi	50 bar	PX4[*]9-750DDUV
0 to 1000 psi	70 bar	PX4[*]9-1.0KDDUV

Comes complete with 5-point NIST traceable calibration certificate.
[*] Enter "5" for PX459 M12 connector or "2" for PX429 twist lock connector (mating PX429 connector sold separately, PT06F10-6S).

Ordering Examples: PX409C-100DDUV, 0 to 100 psi uni-directional wet/dry differential pressure range, 10 mV/V output, 0.08% accuracy, 1/4 NPT fitting, 2 m (6') cable with 1/2 NPT conduit fitting.

PX419-015DDUV, 0 to 15 psi uni-directional wet/dry differential pressure range, 10 mV/V output, 0.08% accuracy, 1/4 NPT fittings, mini DIN connector.

PX429-10WDDUV, 0 to 10 inH₂O uni-directional wet/dry differential pressure range, 10 mV/V output, 0.08% accuracy, 1/4 NPT fittings, twist-lock connector plus PT06F10-6S, mating connector.

CONNECTIONS—mV/V OUTPUT

PX429 TWIST-LOCK		PX419 MINI DIN		PX409 CABLE	
Pin A	+EXC	Pin 1	+EXC	Red	+EXC
Pin B	-EXC	Pin 2	-EXC	Black	-EXC
Pin C	+SIG	Pin 3	+SIG	White	+SIG
Pin D	-SIG	Pin 4	-SIG	Green	-SIG
Pin E	No Connection				
Pin F	No Connection				

DIFFERENTIAL PRESSURE TRANSDUCERS

B

WET/DRY DIFFERENTIAL PRESSURE MODELS

UNI-DIRECTIONAL RANGES WITH 0 to 5 Vdc OUTPUTS

UNI-DIRECTIONAL VOLTAGE OUTPUT SPECIFICATIONS

Output Voltage/Supply Voltage: 0 to 5 Vdc/
10 to 30 Vdc; 0 to 10 Vdc/15 to 30 Vdc
(change "5V" to "10V" in model number)

Current Draw: 10 mA maximum

Maximum Current Output: 2 mA (= 2500 Ω
minimum load resistance)

Output Impedance: 100 Ω

Zero Balance:

Ranges > 2.5psi: ±0.5% typical (1% maximum)

Ranges ≤ 2.5psi: ±1% typical (2% maximum)

Span Setting:

Ranges > 2.5psi: ±0.5% typical (1% maximum)

Ranges ≤ 2.5psi: ±1% typical (2% maximum)

CABLE TERMINATION*

To Order

0 to 5 Vdc OUTPUT, ¼ NPT MALE FITTINGS

RANGE	METRIC	MODEL NO.
0 to 10 inH ₂ O	25 mbar	PX409-10WDDU5V
0 to 1 psi	70 mbar	PX409-001DDU5V
0 to 2.5 psi	170 mbar	PX409-2.5DDU5V
0 to 5 psi	350 mbar	PX409-005DDU5V
0 to 15 psi	1 bar	PX409-015DDU5V
0 to 30 psi	2 bar	PX409-030DDU5V
0 to 50 psi	3.5 bar	PX409-050DDU5V
0 to 100 psi	7 bar	PX409-100DDU5V
0 to 150 psi	10 bar	PX409-150DDU5V
0 to 250 psi	17.5 bar	PX409-250DDU5V
0 to 500 psi	35 bar	PX409-500DDU5V
0 to 750 psi	50 bar	PX409-750DDU5V
0 to 1000 psi	70 bar	PX409-1.0KDDU5V

* To order conduit fitting backend change model number from "PX409" to "PX409C", no additional cost.

MINI DIN TERMINATION

0 to 5 Vdc OUTPUT, ¼ NPT MALE FITTINGS

RANGE	METRIC	MODEL NO.
0 to 10 inH ₂ O	25 mbar	PX419-10WDDU5V
0 to 1 psi	70 mbar	PX419-001DDU5V
0 to 2.5 psi	170 mbar	PX419-2.5DDU5V
0 to 5 psi	350 mbar	PX419-005DDU5V
0 to 15 psi	1 bar	PX419-015DDU5V
0 to 30 psi	2 bar	PX419-030DDU5V
0 to 50 psi	3.5 bar	PX419-050DDU5V
0 to 100 psi	7 bar	PX419-100DDU5V
0 to 150 psi	10 bar	PX419-150DDU5V
0 to 250 psi	17.5 bar	PX419-250DDU5V
0 to 500 psi	35 bar	PX419-500DDU5V
0 to 750 psi	50 bar	PX419-750DDU5V
0 to 1000 psi	70 bar	PX419-1.0KDDU5V

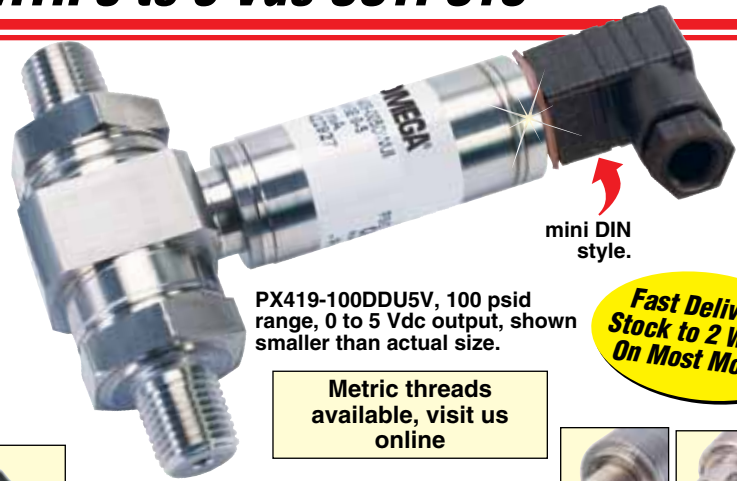

PX419-100DDU5V, 100 psid range, 0 to 5 Vdc output, shown smaller than actual size.

Metric threads available, visit us online

Fast Delivery!
Stock to 2 Weeks
On Most Models

M12 or TWIST-LOCK TERMINATION

0 to 5 Vdc OUTPUT, ¼ NPT MALE FITTINGS

RANGE	METRIC	MODEL NO.
0 to 10 inH ₂ O	25 mbar	PX4[*]9-10WDDU5V
0 to 1 psi	70 mbar	PX4[*]9-001DDU5V
0 to 2.5 psi	170 mbar	PX4[*]9-2.5DDU5V
0 to 5 psi	350 mbar	PX4[*]9-005DDU5V
0 to 15 psi	1 bar	PX4[*]9-015DDU5V
0 to 30 psi	2 bar	PX4[*]9-030DDU5V
0 to 50 psi	3.5 bar	PX4[*]9-050DDU5V
0 to 100 psi	7 bar	PX4[*]9-100DDU5V
0 to 150 psi	10 bar	PX4[*]9-150DDU5V
0 to 250 psi	17.5 bar	PX4[*]9-250DDU5V
0 to 500 psi	35 bar	PX4[*]9-500DDU5V
0 to 750 psi	50 bar	PX4[*]9-750DDU5V
0 to 1000 psi	70 bar	PX4[*]9-1.0KDDU5V

Comes complete with 5-point NIST traceable calibration certificate.

[*] Enter "5" for PX459 M12 connector or "2" for PX429 twist lock connector (mating PX429 connector sold separately).

Note: To order 0 to 10 Vdc output, change "5V" to "10V" in model number, no additional cost.

Ordering Examples: PX409C-100DDU10V, 0 to 100 psi uni-directional wet/dry differential pressure range, 0 to 10 Vdc output, 0.08% accuracy, ¼ NPT fitting, 2 m (6') cable with ½ NPT conduit fitting.

PX419-015DDU5V, 0 to 15 psi uni-directional wet/dry differential pressure range, 0 to 5 Vdc output, 0.08% accuracy, ¼ NPT fittings, mini DIN connector.

PX429-10WDDU5V, 0 to 10 inH₂O uni-directional wet/dry differential pressure range, 0 to 5 Vdc output, 0.08% accuracy, ¼ NPT fittings, twist-lock connector plus PT06F10-S6, mating connector.

CONNECTIONS—VOLTAGE OUTPUT

PX429 TWIST-LOCK		PX419 MINI DIN		PX409 CABLE	
Pin A	+EXC	Pin 1	+EXC	Red	+EXC
Pin B	-COM	Pin 2	-COM	Black	-EXC
Pin C	+SIG	Pin 3	+SIG	White	+SIG
Pin D	No Conn	Pin 4	No Conn	Green	No Conn
Pin E	No Connection				
Pin F	No Connection				

WET/DRY DIFFERENTIAL PRESSURE MODELS

UNI-DIRECTIONAL RANGES WITH 4 to 20 mA OUTPUTS

UNI-DIRECTIONAL mA SPECIFICATIONS

Output: 4 to 20 mA

Supply Voltage: 9 to 30 Vdc;
[9 to 20 Vdc above 105°C (229°F)]

Max Loop Resistance: (Vs-9) x 50 Ω

Zero Balance:

Ranges > 2.5psi: ±0.5% typical (1% maximum)

Ranges ≤ 2.5psi: ±1% typical (2% maximum)

Span Setting:

Ranges > 2.5psi: ±0.5% typical (1% maximum)

Ranges ≤ 2.5psi: ±1% typical (2% maximum)

CABLE TERMINATION*

To Order

4 to 20 mA OUTPUT, ¼ NPT MALE FITTINGS

RANGE	METRIC	MODEL NO.
0 to 10 inH ₂ O	25 mbar	PX409-10WDDUI
0 to 1 psi	70 mbar	PX409-001DDUI
0 to 2.5 psi	170 mbar	PX409-2.5DDUI
0 to 5 psi	350 mbar	PX409-005DDUI
0 to 15 psi	1 bar	PX409-015DDUI
0 to 30 psi	2 bar	PX409-030DDUI
0 to 50 psi	3.5 bar	PX409-050DDUI
0 to 100 psi	7 bar	PX409-100DDUI
0 to 150 psi	10 bar	PX409-150DDUI
0 to 250 psi	17.5 bar	PX409-250DDUI
0 to 500 psi	35 bar	PX409-500DDUI
0 to 750 psi	50 bar	PX409-750DDUI
0 to 1000 psi	70 bar	PX409-1.0KDDUI

* To order conduit fitting backend change model number from "PX409" to "PX409C", no additional cost.

MINI DIN TERMINATION

4 to 20 mA OUTPUT, ¼ NPT MALE FITTINGS

RANGE	METRIC	MODEL NO.
0 to 10 inH ₂ O	25 mbar	PX419-10WDDUI
0 to 1 psi	70 mbar	PX419-001DDUI
0 to 2.5 psi	170 mbar	PX419-2.5DDUI
0 to 5 psi	350 mbar	PX419-005DDUI
0 to 15 psi	1 bar	PX419-015DDUI
0 to 30 psi	2 bar	PX419-030DDUI
0 to 50 psi	3.5 bar	PX419-050DDUI
0 to 100 psi	7 bar	PX419-100DDUI
0 to 150 psi	10 bar	PX419-150DDUI
0 to 250 psi	17.5 bar	PX419-250DDUI
0 to 500 psi	35 bar	PX419-500DDUI
0 to 750 psi	50 bar	PX419-750DDUI
0 to 1000 psi	70 bar	PX419-1.0KDDUI

Fast Delivery!
Stock to 2 Weeks
On Most Models



Twist-lock style.

PX429-005DDUI, 5 psid range, 4 to 20 mA output, shown smaller than actual size.

Metric threads available, visit us online



M12 or TWIST-LOCK TERMINATION

4 to 20 mA OUTPUT, ¼ NPT MALE FITTINGS

RANGE	METRIC	MODEL NO.
0 to 10 inH ₂ O	25 mbar	PX4[*]9-10WDDUI
0 to 1 psi	70 mbar	PX4[*]9-001DDUI
0 to 2.5 psi	170 mbar	PX4[*]9-2.5DDUI
0 to 5 psi	350 mbar	PX4[*]9-005DDUI
0 to 15 psi	1 bar	PX4[*]9-015DDUI
0 to 30 psi	2 bar	PX4[*]9-030DDUI
0 to 50 psi	3.5 bar	PX4[*]9-050DDUI
0 to 100 psi	7 bar	PX4[*]9-100DDUI
0 to 150 psi	10 bar	PX4[*]9-150DDUI
0 to 250 psi	17.5 bar	PX4[*]9-250DDUI
0 to 500 psi	35 bar	PX4[*]9-500DDUI
0 to 750 psi	50 bar	PX4[*]9-750DDUI
0 to 1000 psi	70 bar	PX4[*]9-1.0KDDUI

Comes complete with 5-point NIST traceable calibration certificate.

[*] Enter "5" for PX459 M12 connector or "2" for PX429 twist lock connector (mating PX429 connector sold separately).

Ordering Examples: PX409C-100DDUI, 0 to 100 psi uni-directional wet/dry differential pressure range, 4 to 20 mA output, 0.08% accuracy, ¼ NPT fitting, 2 m (6') cable with ½ NPT conduit fitting.

PX419-015DDUI, 0 to 15 psi uni-directional wet/dry differential pressure range, 4 to 20 mA output, 0.08% accuracy, ¼ NPT fittings, mini DIN connector.

PX429-10WDDUI, 0 to 10 inH₂O uni-directional wet/dry differential pressure range, 4 to 20 mA output, 0.08% accuracy, ¼ NPT fittings, twist-lock connector plus PT06F10-6S, mating connector.

CONNECTIONS—CURRENT OUTPUT

PX429 TWIST-LOCK		PX419 MINI DIN		PX409 CABLE	
Pin A	+SUP	Pin 1	+SUP	Red	+SUP
Pin B	-SUP	Pin 2	-SUP	Black	-SUP
Pin C	No Conn	Pin 3	No Conn	White	No Conn
Pin D	No Conn	Pin 4	No Conn	Green	No Conn
Pin E	No Connection				
Pin F	No Connection				