

INDUSTRIAL WET/WET DIFFERENTIAL PRESSURE—HIGH OVERPRESSURE CAPACITY

STANDARD AND METRIC MODELS

0-30 to 0-5000 psi-Standard Models

0-2 to 0-350 bar-Metric Models

Differential Pressure

mV/V Output

0 to 5 Vdc Output

4 to 20 mA Output

1 bar = 14.5 psi

1 kg/cm² = 14.22 psi

1 atmosphere = 14.7 psi = 29.93

inHg = 760.2 mmHg = 1.014 bar

PX80/PXM80 Series



- ✓ Low Differential Pressure at High Line Pressure—1500 psi (100 bar) Standard
- ✓ All Stainless Steel Construction
- ✓ Sealed for Harsh Environments
- ✓ Rugged Lightning-Protected Housing Available, Style 5

OMEGA's PX80/PXM80 is a heavy-duty, wet/wet, differential pressure transducer that comes in ranges of 0-30 to 0-5000 psi (0-2 to 0-350 bar). Models are available in any of 3 outputs: mV/V, amplified 0 to 5 Vdc, or 4 to 20 mA. All are suitable for interface with most PLCs and computer-based control systems. An extremely high overpressure capacity of 1500 psi or 150% of capacity (whichever is greater) makes the PX80/PXM80 an extremely durable transducer. The all stainless steel construction and high overpressure protection offer high reliability in harsh industrial environments.



DIFFERENTIAL PRESSURE TRANSDUCERS **B**

DIFFERENTIAL PRESSURE TRANSDUCERS

Style 5 sealed metal terminal box most ranges, visit us online.

SPECIFICATIONS

mV/V Output

Electrical:

Excitation: 10 Vdc (15 V maximum)

Output: 2 mV/V nominal

Bridge Resistance: 350 Ω

Zero Balance: ±1% FSO

5 Vdc Output

Electrical:

Excitation: 24 to 32 Vdc

Output: 0 to 5 Vdc ±10% adj

Zero Balance: 0 V ±10% adj

4 to 20 mA Output

Electrical:

Excitation: 10 to 40 Vdc

Output: 4 to 20 mA ±0.8 mA adj

Max Loop Resistance:

(Input voltage – 12) x 50

Zero Balance: 4 mA ± 0.4 mA adj

COMMON SPECIFICATIONS

Performance:

Linearity: ±0.25% FSO

Hysteresis: ±0.10% FSO

Repeatability: ±0.1% FSO

Operating Temp Range:

mV/V: -73 to 163°C (-100 to 325°F)

Amplified: -46 to 107°C

(-50 to 225°F)

Compensated Temp Range:

mV/V: 17 to 71°C (60 to 160°F)

Thermal Effects:

Zero: 0.009% FSO/°C

(mV and 5V)

Zero: 0.013% FSO/°C (4 to 20 mA)

Span: 0.009% rdg/°C

Pressure:

Line Pressure: 1500 psi (100 bar) or 150% of rated pressure, whichever is greater

Burst Pressure: 6000 psi (414 bar) minimum

Wetted Parts: 17-4 PH stainless steel and Buna-N O-ring

Pressure Port: See dimensional drawings on following pages

Electrical Termination:

Style 0 = 3 m (10') cable

Style 1 = PTIH-10-6P (or equiv)

Style 5 = Metal terminal box (4 to 20 mA output models only)

Style 6 = mini DIN

Mating Connector:

Style 1: PT06F10-6S

(sold separately)

Style 6: Mating connector

(included)

Weight: 5 lb



STANDARD
PX80D5-050DI
shown smaller than
actual size.

STANDARD AND METRIC CUSTOM CONFIGURATIONS

MODEL NUMBER SPECIFICATION:

PXM80D0-100DV

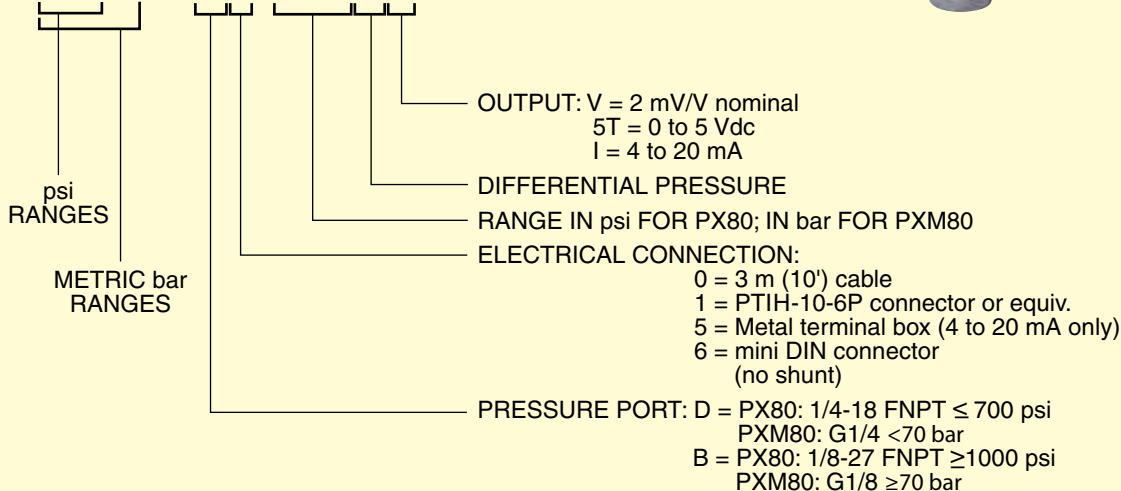

To order extra cable on cable style models, add suffix “-(length in feet)FT” and add cost/ft beyond the standard 3 m (10') length.

Ordering Examples: PX80B5-1KDI, 1000 psid range model with 4 to 20 mA output and a lightning-protected amplifier housing
PX80D0-030DI-25FT, 30 psid range model, 4 to 20 mA output and 7.6m (25') cable.

PX80D1-200DV, 200 psid range model with mV/V output and twist-lock 6 pin connector. PT06F10-6S, mating connector (sold separately).

mV/V OUTPUT STANDARD RANGES

mV/V Output
0-30 to 0-5000 psi
(0-2 to 0-350 bar)
Differential Pressure

PX80 Series mV Models



- ✓ Low Differential Pressure at High Line Pressure—1500 psi Standard
- ✓ All Stainless Steel Construction
- ✓ Sealed for Harsh Environments
- ✓ High Overpressure

CONNECTIONS mV/V

	PIN	Cable	DIN
+Output	A	Green	2
-Output	B	White	3
-Input	C	Black	GRND
+Input	D	Red	1
Shunt	E	Blue	
Shunt	F	Orange	

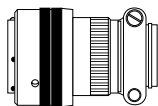

Style 1 Mating Connector
PT06F10-6S
 sold separately.

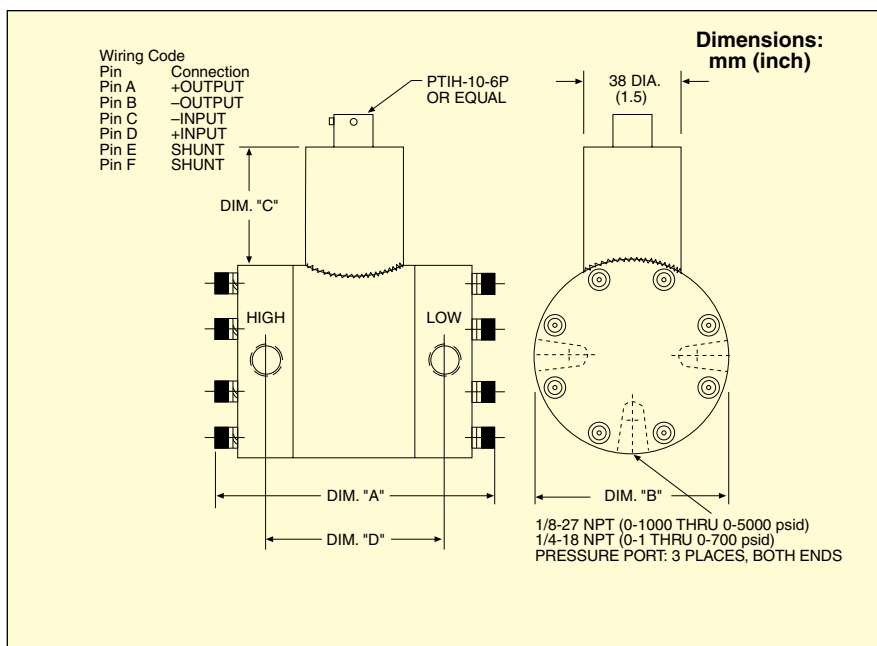

Dimensions: mm (inch)

Capacity	A	B	C	D
<1000 psi	111 (4.38)	76 (3.0)	49 (1.94)	75 (2.94)
≥1000 psi	76 (3.0) + Fitting	51 (2.0)	54 (2.13)	N/A

STANDARD MODELS

To Order			
Models with mV Output and Integral Connector			
RANGE		MODEL NO.	COMPATIBLE METERS*
0 to 30 psid	0 to 2.1 bar	PX80D[*]-030DV	DP41-S, DP25B-S
0 to 50 psid	0 to 3.4 bar	PX80D[*]-050DV	DP41-S, DP25B-S
0 to 100 psid	0 to 6.9 bar	PX80D[*]-100DV	DP41-S, DP25B-S
0 to 200 psid	0 to 13.8 bar	PX80D[*]-200DV	DP41-S, DP25B-S
0 to 300 psid	0 to 20.7 bar	PX80D[*]-300DV	DP41-S, DP25B-S
0 to 500 psid	0 to 34.5 bar	PX80D[*]-500DV	DP41-S, DP25B-S
0 to 700 psid	0 to 48.3 bar	PX80D[*]-700DV	DP41-S, DP25B-S
0 to 1000 psid	0 to 68.9 bar	PX80B[*]-1KDV	DP41-S, DP25B-S
0 to 1500 psid	0 to 103 bar	PX80B[*]-1.5KDV	DP41-S, DP25B-S
0 to 2000 psid	0 to 138 bar	PX80B[*]-2KDV	DP41-S, DP25B-S
0 to 2500 psid	0 to 172 bar	PX80B[*]-2.5KDV	DP41-S, DP25B-S
0 to 3000 psid	0 to 207 bar	PX80B[*]-3KDV	DP41-S, DP25B-S
0 to 5000 psid	0 to 345 bar	PX80B[*]-5KDV	DP41-S, DP25B-S

Comes complete with 5-point NIST traceable calibration.

* Visit us online for compatible meters.

[*] Insert "0" for 3 m (10') cable, "1" for twist-lock 6 pin connector, or "6" for mini DIN connector.

Ordering Examples: PX80D1-030DV, ±30 psid range differential transducer with 1/4-18 NPT pressure fittings, twist-lock 6 pin electrical connector and mV/V output. PT06F10-6S, mating connector (sold separately).

PX80B1-1KDV, ±1000 psid range differential transducer with 1/8-27 NPT pressure fittings, twist-lock 6 pin electrical connector and mV/V output.

mV/V OUTPUT METRIC RANGES

mV/V Output
0-2 to 0-350 bar
0-30 to 0-5000 psi
Differential Pressure

PXM80 Series mV Models

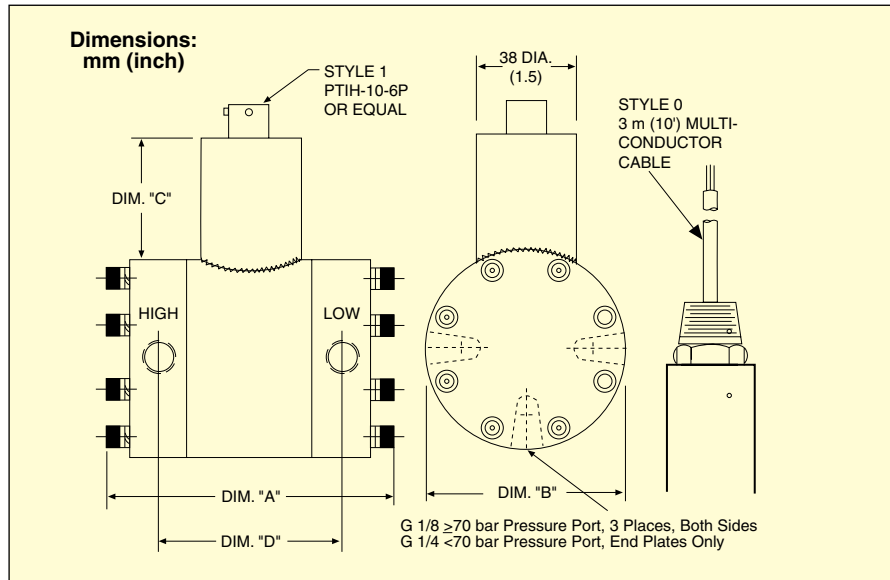

Dimensions: mm (inch)

CAPACITY	A	B	C	D
<70 bar	111 (4.38)	76 (3.0)	49 (1.94)	75 (2.94)
≥70 bar	76 (3.0) + fitting	51 (2.0)	54 (2.13)	N/A

- ✓ Low Differential Pressure at High Line Pressure—100 bar Standard
- ✓ All Stainless Steel Construction
- ✓ Sealed for Harsh Environments
- ✓ High Overpressure

METRIC MODELS

To Order

Models with mV/V Output, Specify Electrical Termination

RANGE	MODEL NO.	COMPATIBLE METERS*	
DIFFERENTIAL PRESSURE			
0 to 2 bar	0 to 29 psi	PXM80MD[*]-002BARDV	DP41-S, DP25B-S
0 to 3.50 bar	0 to 51 psi	PXM80MD[*]-3.50BARDV	DP41-S, DP25B-S
0 to 7 bar	0 to 102 psi	PXM80MD[*]-007BARDV	DP41-S, DP25B-S
0 to 14 bar	0 to 203 psi	PXM80MD[*]-014BARDV	DP41-S, DP25B-S
0 to 20 bar	0 to 290 psi	PXM80MD[*]-020BARDV	DP41-S, DP25B-S
0 to 35 bar	0 to 508 psi	PXM80MD[*]-035BARDV	DP41-S, DP25B-S
0 to 50 bar	0 to 725 psi	PXM80MD[*]-050BARDV	DP41-S, DP25B-S
0 to 70 bar	0 to 1015 psi	PXM80MB[*]-070BARDV	DP41-S, DP25B-S
0 to 100 bar	0 to 1450 psi	PXM80MB[*]-100BARDV	DP41-S, DP25B-S
0 to 140 bar	0 to 2031 psi	PXM80MB[*]-140BARDV	DP41-S, DP25B-S
0 to 175 bar	0 to 2538 psi	PXM80MB[*]-175BARDV	DP41-S, DP25B-S
0 to 200 bar	0 to 2901 psi	PXM80MB[*]-200BARDV	DP41-S, DP25B-S
0 to 350 bar	0 to 5076 psi	PXM80MB[*]-350BARDV	DP41-S, DP25B-S

CONNECTIONS mV/V

	PIN	Cable	DIN
+Output	A	Green	2
-Output	B	White	3
-Input	C	Black	GRND
+Input	D	Red	1
Shunt	E	Blue	
Shunt	F	Orange	

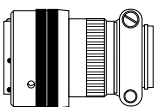

Style 1 Mating Connector
 PT06F10-6S
 sold separately.

Comes complete with 5-point NIST traceable calibration.

[*] Insert "0" for 3 m (10') cable, "1" for twist-lock 6 pin connector or "6" for mini DIN connector
 * Visit us online for compatible meters.

To order extra cable on cable style models, add suffix "(total length in meters)M" and add cost/m beyond the standard 3 m (10') length.

Ordering Examples: PXM80MD0-002BARDV-10M, 2 bar range differential transducer with G 1/4 female pressure fittings, 10 m (32') cable and mV/V output. PXM80MB1-100BARDV, 100 bar range differential transducer with G 1/8 pressure fittings, twist-lock 6 pin electrical connector and mV/V output. PT06F10-6S, mating connector (sold separately).

0 to 5 Vdc OUTPUT STANDARD RANGES

0 to 5 Vdc Output
0-30 to 0-5000 psi
(0-2 bar to 0-350 bar)
Differential Pressure

PX80 Series

5V Models



- ✓ Low Differential Pressure at High Line Pressure—1500 psi Standard
- ✓ All Stainless Steel Construction
- ✓ Sealed for Harsh Environments
- ✓ High Overpressure

STANDARD
 PX80B1-2KD5T
 shown smaller
 than actual
 size.



Twist-lock style.

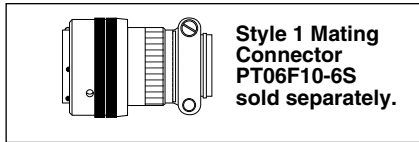
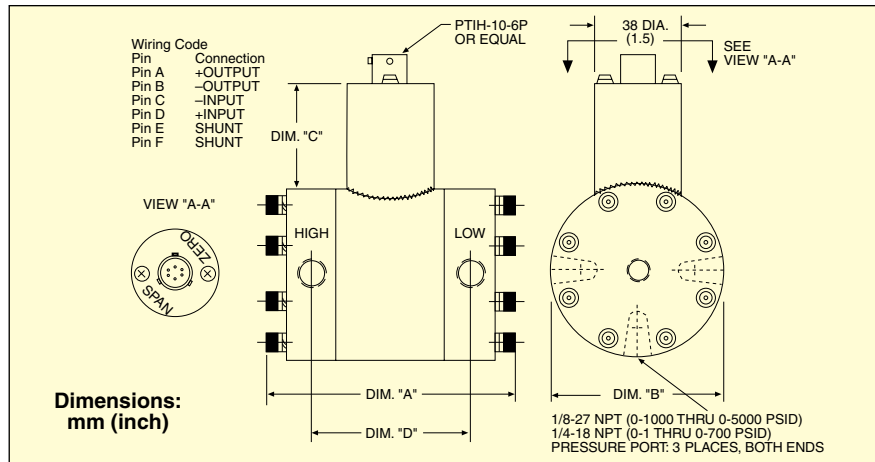

CONNECTIONS 5 Vdc

	PIN	Cable	DIN
+Output	A	Green	2
-Output	B	White	3
-Input	C	Black	GRND
+Input	D	Red	1
Shunt	E	Blue	
Shunt	F	Orange	

Dimensions: mm (inch)

CAPACITY	A	B	C	D
<1000 psi	111 (4.38)	76 (3.0)	62 (2.44)	75 (2.94)
≥1000 psi	76 (3.0) + Fitting	51 (2.0)	76 (3.0)	N/A

STANDARD MODELS

To Order

Models with 0 to 5 V Output and Integral Connector

RANGE	MODEL NO.	COMPATIBLE METERS*
0 to 30 psid 0 to 2 bar	PX80D[*]-030D5T	DP41-E, DP25B-E, DP24-E
0 to 50 psid 0 to 3.4 bar	PX80D[*]-050D5T	DP41-E, DP25B-E, DP24-E
0 to 100 psid 0 to 6.9 bar	PX80D[*]-100D5T	DP41-E, DP25B-E, DP24-E
0 to 200 psid 0 to 13.8 bar	PX80D[*]-200D5T	DP41-E, DP25B-E, DP24-E
0 to 300 psid 0 to 20.7 bar	PX80D[*]-300D5T	DP41-E, DP25B-E, DP24-E
0 to 500 psid 0 to 34.5 bar	PX80D[*]-500D5T	DP41-E, DP25B-E, DP24-E
0 to 700 psid 0 to 48.3 bar	PX80D[*]-700D5T	DP41-E, DP25B-E, DP24-E
0 to 1000 psid 0 to 68.9 bar	PX80B[*]-1KD5T	DP41-E, DP25B-E, DP24-E
0 to 1500 psid 0 to 103 bar	PX80B[*]-1.5KD5T	DP41-E, DP25B-E, DP24-E
0 to 2000 psid 0 to 138 bar	PX80B[*]-2KD5T	DP41-E, DP25B-E, DP24-E
0 to 2500 psid 0 to 172 bar	PX80B[*]-2.5KD5T	DP41-E, DP25B-E, DP24-E
0 to 3000 psid 0 to 207 bar	PX80B[*]-3KD5T	DP41-E, DP25B-E, DP24-E
0 to 5000 psid 0 to 345 bar	PX80B[*]-5KD5T	DP41-E, DP25B-E, DP24-E

Comes complete with 5-point NIST traceable calibration.

* Visit us online for compatible meters.

[*] Insert "0" for 3 m (10') cable, "1" for twist-lock 6 pin connector, or "6" for mini DIN connector.

Ordering Examples: PX80D1-050D5T, 50 psid range differential transducer with 0 to 5 Vdc output, 1/4-18 NPT pressure fittings, and twist-lock 6 pin electrical connector. PT06F10-6S, mating connector (sold separately). PX80B0-1KD5T, 1000 psid range differential transducer with 0 to 5 Vdc output, 1/8-27 NPT pressure fittings, and 3 m (10') PVC cable.

0 to 5 Vdc OUTPUT **METRIC** RANGES

0 to 5 Vdc Output
0-2 to 0-350 bar
0-30 to 0-5000 psi
Differential Pressure

PXM80 Series 5V Models



- ✓ Low Differential Pressure at High Line Pressure—100 bar Standard
- ✓ All Stainless Steel Construction
- ✓ Sealed for Harsh Environments
- ✓ High Overpressure

METRIC
 PXM80MD1-007BARD5T
 shown smaller than actual size.

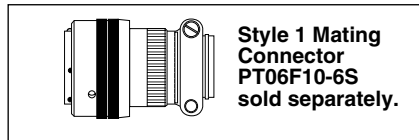
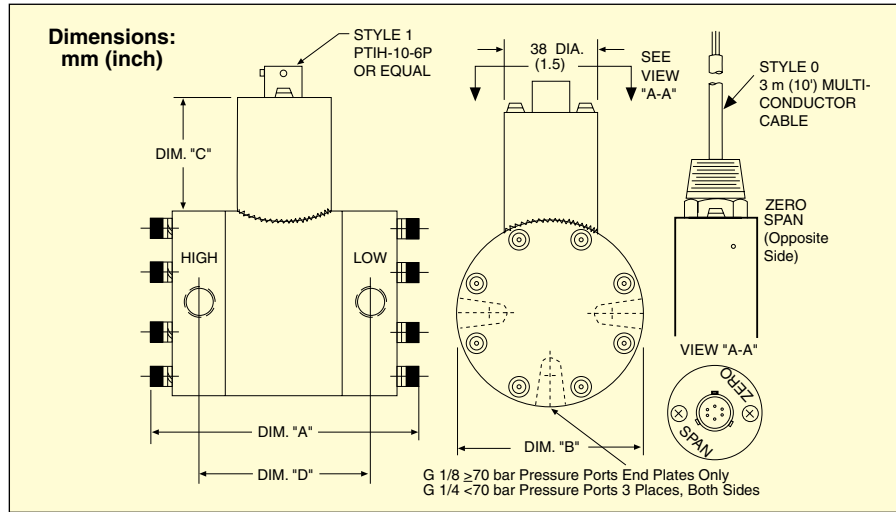

CONNECTIONS 5 Vdc			
	PIN	Cable	DIN
+Output	A	Green	2
-Output	B	White	3
-Input	C	Black	GRND
+Input	D	Red	1
Shunt	E	Blue	
Shunt	F	Orange	

Dimensions: mm (inch)

CAPACITY	A	B	C	D
<70 bar	111 (4.38)	76 (3.0)	62 (2.44)	75 (2.94)
≥70 bar	76 (3.0) + fitting	51 (2.0)	76 (3.0)	N/A

METRIC MODELS

To Order

Models with 0 to 5 V Output, Specify Electrical Termination

RANGE	MODEL NO.	COMPATIBLE METERS*
DIFFERENTIAL PRESSURE		
0 to 2 bar	0 to 29 psi	PXM80MD[*]-002BARD5T DP41-E, DP25B-E, DP24-E
0 to 3.50 bar	0 to 51 psi	PXM80MD[*]-3.50BARD5T DP41-E, DP25B-E, DP24-E
0 to 7 bar	0 to 102 psi	PXM80MD[*]-007BARD5T DP41-E, DP25B-E, DP24-E
0 to 14 bar	0 to 203 psi	PXM80MD[*]-014BARD5T DP41-E, DP25B-E, DP24-E
0 to 20 bar	0 to 290 psi	PXM80MD[*]-020BARD5T DP41-E, DP25B-E, DP24-E
0 to 35 bar	0 to 508 psi	PXM80MD[*]-035BARD5T DP41-E, DP25B-E, DP24-E
0 to 50 bar	0 to 725 psi	PXM80MD[*]-050BARD5T DP41-E, DP25B-E, DP24-E
0 to 70 bar	0 to 1015 psi	PXM80MB[*]-070BARD5T DP41-E, DP25B-E, DP24-E
0 to 100 bar	0 to 1450 psi	PXM80MB[*]-100BARD5T DP41-E, DP25B-E, DP24-E
0 to 140 bar	0 to 2031 psi	PXM80MB[*]-140BARD5T DP41-E, DP25B-E, DP24-E
0 to 175 bar	0 to 2538 psi	PXM80MB[*]-175BARD5T DP41-E, DP25B-E, DP24-E
0 to 200 bar	0 to 2901 psi	PXM80MB[*]-200BARD5T DP41-E, DP25B-E, DP24-E
0 to 350 bar	0 to 5076 psi	PXM80MB[*]-350BARD5T DP41-E, DP25B-E, DP24-E

Comes complete with 5-point NIST traceable calibration. * Visit us online for compatible meters.

[*] Insert "0" for 3 m (10') cable, "1" for twist-lock 6 pin connector or "6" for mini DIN connector. To order extra cable on cable style models, add suffix "--(Total length in meters)M" and add cost/m beyond the standard 3 m (10') length.

Ordering Examples: PXM80MD0-002BARD5T-10M, 2 bar range differential transmitter with G 1/4 female pressure fittings, 10 m (32') cable and 0 to 5 Vdc output.

PXM80MB1-100BARD5T, 100 bar range differential transmitter with G 1/2 pressure fittings, for twist-lock 6 pin electrical connector and 0 to 5 Vdc output.
 PT06F10-6S, mating connector (sold separately).

4 to 20 mA OUTPUT STANDARD RANGES

4 to 20 mA Output
0-30 to 0-5000 psid
(0-2 bar to 0-350 bar)
Differential Pressure

PX80 Series

4 to 20 mA Models



- ✓ Low Differential Pressure at High Line Pressure—1500 psi Standard
- ✓ All Stainless Steel Construction
- ✓ Sealed for Harsh Environments
- ✓ High Overpressure

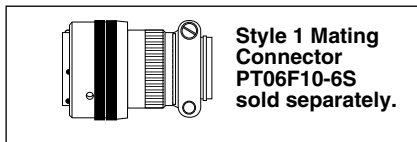
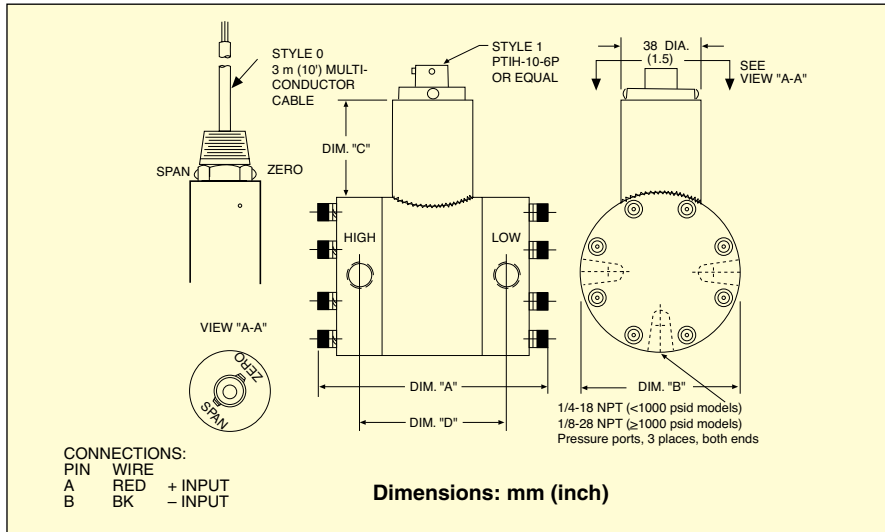

CONNECTIONS 4 to 20 mA

	PIN	Cable	DIN
+ Input	A	Red	1
- Input	B	Black	2

Dimensions: mm (inch)

CAPACITY	A	B	C	D
<1000 psi	111 (4.38)	75 (2.94)	62 (2.44)	76 (3.0)
≥1000 psi	76 (3.0) + fitting	51 (2.0)	76 (3.0)	N/A

STANDARD MODELS

To Order			
Models with 4 to 20 mA Output			
RANGE psid	RANGE bar	MODEL NO.	COMPATIBLE METERS*
0 to 30	0 to 2	PX80D[*]-030DI	DP41-E, DP25B-E, DP24-E
0 to 50	0 to 3.4	PX80D[*]-050DI	DP41-E, DP25B-E, DP24-E
0 to 100	0 to 6.9	PX80D[*]-100DI	DP41-E, DP25B-E, DP24-E
0 to 200	0 to 13.8	PX80D[*]-200DI	DP41-E, DP25B-E, DP24-E
0 to 300	0 to 20.7	PX80D[*]-300DI	DP41-E, DP25B-E, DP24-E
0 to 500	0 to 34.5	PX80D[*]-500DI	DP41-E, DP25B-E, DP24-E
0 to 700	0 to 48.3	PX80D[*]-700DI	DP41-E, DP25B-E, DP24-E
0 to 1000	0 to 68.9	PX80B[*]-1KDI	DP41-E, DP25B-E, DP24-E
0 to 1500	0 to 103	PX80B[*]-1.5KDI	DP41-E, DP25B-E, DP24-E
0 to 2000	0 to 138	PX80B[*]-2KDI	DP41-E, DP25B-E, DP24-E
0 to 2500	0 to 172	PX80B[*]-2.5KDI	DP41-E, DP25B-E, DP24-E
0 to 3000	0 to 207	PX80B[*]-3KDI	DP41-E, DP25B-E, DP24-E
0 to 5000	0 to 345	PX80B[*]-5KDI	DP41-E, DP25B-E, DP24-E

Comes complete with 5-point NIST traceable calibration.

* Visit us online for compatible meters.

[*] Insert "0" for 3 m (10') cable, "1" for twist-lock 6 pin connector, or "6" for mini DIN connector. To order extra cable length, add suffix "(Length in feet)FT" to model number and add cost/ft beyond standard 3 m (10') length.

Ordering Examples: PX80D0-050DI-25FT, 50 psid differential transmitter with 7.6 m (25') cable and 1/4-18 NPT fitting. PX80B0-1.5KDI, 1500 psid differential transmitter with 3 m (10') cable, and 1/4-27 NPT fitting.

4 to 20 mA OUTPUT **METRIC** RANGES

4 to 20 mA Output
0-2 to 0-350 bar
0-30 to 0-5000 psi
Differential Pressure

PXM80 Series 4 to 20 mA Models

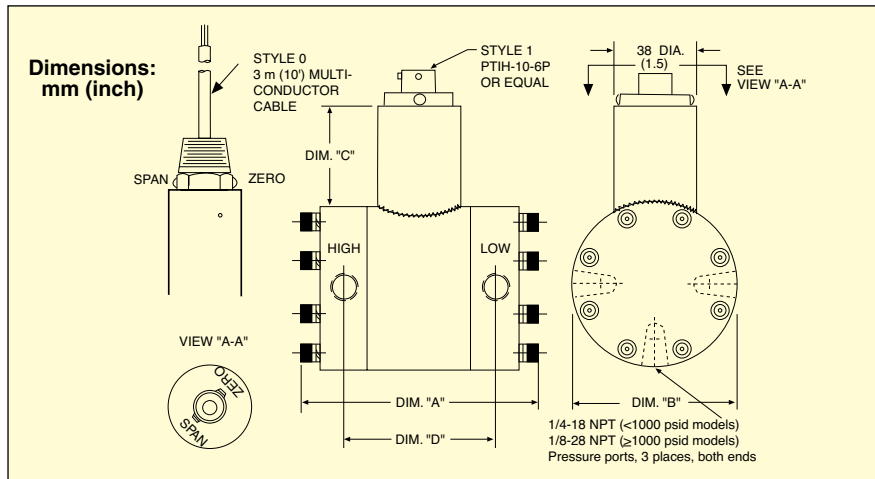

- ✓ Low Differential Pressure at High Line Pressure—100 bar Standard
- ✓ All Stainless Steel Construction
- ✓ Sealed for Harsh Environments
- ✓ High Overpressure

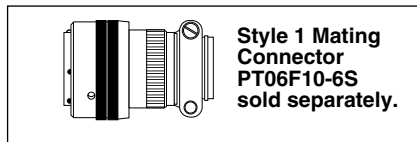

CONNECTIONS 4 to 20 mA			
	PIN	Cable	DIN
+ Input	A	Red	1
- Input	B	Black	2

Dimensions: mm (inch)

CAPACITY	A	B	C	D
<70 bar	111 (4.38)	75 (2.94)	62 (2.44)	76 (3.0)
≥70 bar	76 (3.0) + fitting	51 (2.0)	76 (3.0)	N/A

METRIC MODELS

To Order			
Models with 4 to 20 mA Output, Specify Electrical Termination			
RANGE	MODEL NO.	COMPATIBLE METERS*	
DIFFERENTIAL PRESSURE			
0 to 2 bar	0 to 29 psi	PXM80MD[*]-002BARDI	DP41-E, DP25B-E, DP24-E
0 to 3.50 bar	0 to 51 psi	PXM80MD[*]-3.50BARDI	DP41-E, DP25B-E, DP24-E
0 to 7 bar	0 to 102 psi	PXM80MD[*]-007BARDI	DP41-E, DP25B-E, DP24-E
0 to 14 bar	0 to 203 psi	PXM80MD[*]-014BARDI	DP41-E, DP25B-E, DP24-E
0 to 20 bar	0 to 290 psi	PXM80MD[*]-020BARDI	DP41-E, DP25B-E, DP24-E
0 to 35 bar	0 to 508 psi	PXM80MD[*]-035BARDI	DP41-E, DP25B-E, DP24-E
0 to 50 bar	0 to 725 psi	PXM80MD[*]-050BARDI	DP41-E, DP25B-E, DP24-E
0 to 70 bar	0 to 1015 psi	PXM80MB[*]-070BARDI	DP41-E, DP25B-E, DP24-E
0 to 100 bar	0 to 1450 psi	PXM80MB[*]-100BARDI	DP41-E, DP25B-E, DP24-E
0 to 140 bar	0 to 2031 psi	PXM80MB[*]-140BARDI	DP41-E, DP25B-E, DP24-E
0 to 175 bar	0 to 2538 psi	PXM80MB[*]-175BARDI	DP41-E, DP25B-E, DP24-E
0 to 200 bar	0 to 2901 psi	PXM80MB[*]-200BARDI	DP41-E, DP25B-E, DP24-E
0 to 350 bar	0 to 5076 psi	PXM80MB[*]-350BARDI	DP41-E, DP25B-E, DP24-E

Comes complete with 5-point NIST traceable calibration. * Visit us online for compatible meters

[*] Insert "0" for 3 m (10') cable, "1" for twist-lock 6 pin connector, "5" for metal terminal box or "6" for mini DIN connector. To order extra cable on cable style models, add suffix "-(total length in meters)M" and add cost/m beyond the standard 3 m (10') length.

Ordering Examples: **PXM80MD0-002BARDI-10M**, 2 bar range differential transmitter with G 1/4 female pressure fittings, 10 m (32') cable and 4 to 20 mA output. **PXM80MB1-100BARDI**, 100 bar range differential transmitter with G 1/8 pressure fittings, twist-lock 6 pin electrical connector and 4 to 20 mA output. **PT06F10-6S**, mating connector (sold separately).

