

COMPACT INDUSTRIAL WET/WET DIFFERENTIAL PRESSURE TRANSDUCER

STANDARD AND METRIC MODELS

**0-2 to 0-500 psid-
Standard Models**
**0-140 mbar to 0-35 bar-
Metric Models**

Differential Pressure
mV/V Output
0 to 5 Vdc Output
4 to 20 mA Output

1 bar = 14.5 psi
1 kg/cm² = 14.22 psi
1 atmosphere = 14.7 psi = 29.93 inHg = 760.2 mmHg = 1.014 bar

PX81/PXM81 Series



- ✓ High-Accuracy Wet/Wet Differential Pressure
- ✓ All Stainless Steel Construction for Harsh Industrial Environments
- ✓ High Operating Temperature
- ✓ 5-Point Calibration Provided: 0%, 50%, 100%, 50%, 0%

OMEGA's PX81/PXM81 Series wet/wet, differential pressure transducers are compact and highly accurate, designed for industrial applications in which low drift and long-term reliability are important. Their small temperature-compensation error minimizes errors due to changing process temperatures, and the rugged all stainless steel construction allows the PX81/PXM81 to withstand typical harsh environments found in chemical and industrial plants. Available with either mV/V, 0 to 5 Vdc, or 4 to 20 mA outputs, PX81/PXM81 Series transducers will interface with most control systems.



WET/WET DIFFERENTIAL PRESSURE TRANSDUCERS

SPECIFICATIONS

mV/V Output

Excitation: 10 Vdc
(15 V max)

Output: 3 mV/V nominal

Bridge Resistance:
350 Ω minimum

Zero Balance: ±1% FSO

Shunt: 80% FSO

5 Vdc Output

Excitation: 24 to 32 Vdc

Output: 0 to 5 Vdc ±10% adj

Zero Balance: 0 V ±10% adj

4 to 20mA Output

Excitation: 10 to 40 Vdc

Output: 4 to 20 mA ±10%

Zero Balance:

4 mA +10% -2% adj

Shunt: 80% FSO

COMMON SPECIFICATIONS

Accuracy: ±0.25% linearity, hysteresis and repeatability combined

Environmental:

Operating Temp Range:

mV/V: -73 to 163°C (-100 to 325°F)

5T and I: -46 to 121°C (-50 to 250°C)

Compensated Temp Range:

17 to 71°C (60 to 160°F)

Thermal Effects:

mV/V and 5 V:

Zero: ±0.0054% FSO/°C

Span: ±0.0054% rdg/°C

4 to 20 mA:

Zero: ±0.009% FSO/°C

Span: ±0.009% rdg/°C

Pressure:

Safe Overpressure:

150% rated pressure

Line Pressure: 150% rated pressure
(applied simultaneously to both sides)

Burst Pressure: 300%
rated pressure

Mechanical:

Wetted Parts: 17-4 PH
stainless steel

Pressure Port: See dimensional
drawings on following pages

Electrical Connection:

Style 0: 3 m (10') cable

Style 1: PTIH-10-6P (or equal)

Style 6: mini DIN

Mating Connector:

Style 1: PT06F10-6S

(sold separately)

Style 6: Mating connector included

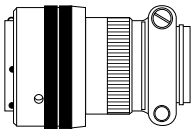

**Style 1 Mating
Connector
PT06F10-6S
sold separately.**



**STANDARD
PX81D0-020DV,
shown actual size.**

STANDARD AND METRIC CUSTOM CONFIGURATIONS

MODEL NUMBER SPECIFICATION:

PXM81D0-020DV

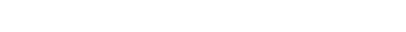
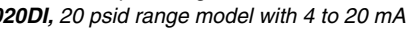
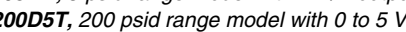
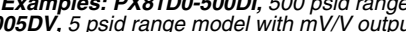
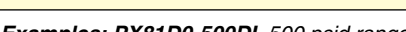
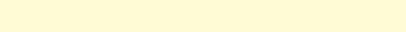
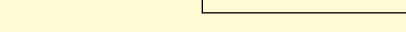
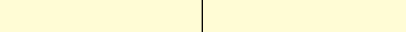
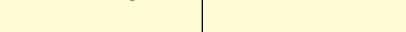
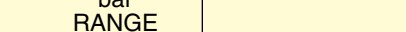
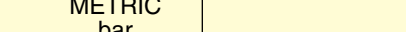
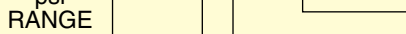
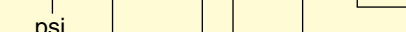
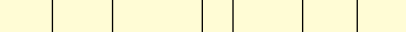
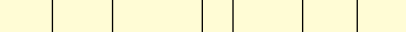
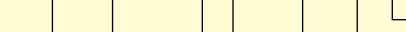
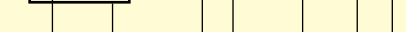
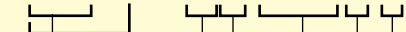

OUTPUT: V = 3 mV/V nominal
5T = 0 to 5 Vdc
I = 4 to 20 mA

DIFFERENTIAL PRESSURE

RANGE IN psi FOR PX81; mbar FOR PXM81

ELECTRICAL CONNECTION:

0 = 3 m (10') cable
1 = PTIH-10-6P connector or equiv.
6 = mini DIN connector
(no shunt)

PRESSURE PORT: D = 1/4-18 FNPT
MD = G1/4

Ordering Examples: *PX81D0-500DI*, 500 psid range model with 4 to 20 mA output and 3 m (10') PVC cable.

PX81D0-005DV, 5 psid range model with mV/V output and 3 m (10') PVC cable.

PX81D1-200D5T, 200 psid range model with 0 to 5 Vdc output and integral connector. *PT06F10-6S*, mating connector.

PX81D0-020DI, 20 psid range model with 4 to 20 mA output and 3 m (10') cable.

mV/V OUTPUT STANDARD RANGES

mV/V Output
0-5 to 0-500 psid
0-0.34 to 34.5 bar
Differential Pressure

PX81 Series mV Models



- ✓ High-Accuracy Wet/Wet Differential Pressure
- ✓ All Stainless Steel Construction for Harsh Industrial Environments
- ✓ High Operating Temperature
- ✓ 5-Point Calibration Provided: 0%, 50%, 100%, 50%, 0%

CONNECTIONS mV/V

	PIN	Cable	DIN
+Output	A	Green	2
-Output	B	White	3
-Input	C	Black	GRND
+Input	D	Red	1
Shunt	E	Blue	
Shunt	F	Orange	

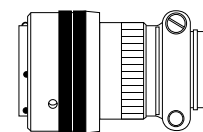

Style 1 Mating Connector
PT06F10-6S
 sold separately.



STANDARD
 PX81D1-100D5T, shown
 than size.

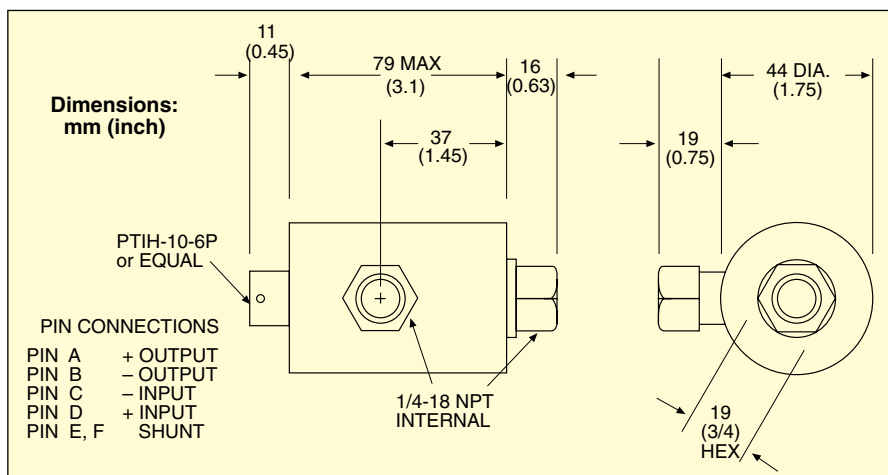

STANDARD MODELS

To Order			
MODELS WITH mV OUTPUT WITH 1/4 NPT FITTING			
RANGE		MODEL NO.	COMPATIBLE METERS*
0 to 5 psid	0 to 0.34 bar	PX81D[*]-005DV	DP41-S, DP25B-S
0 to 10 psid	0 to 0.69 bar	PX81D[*]-010DV	DP41-S, DP25B-S
0 to 20 psid	0 to 1.4 bar	PX81D[*]-020DV	DP41-S, DP25B-S
0 to 50 psid	0 to 3.4 bar	PX81D[*]-050DV	DP41-S, DP25B-S
0 to 100 psid	0 to 6.9 bar	PX81D[*]-100DV	DP41-S, DP25B-S
0 to 200 psid	0 to 13.8 bar	PX81D[*]-200DV	DP41-S, DP25B-S
0 to 300 psid	0 to 20.7 bar	PX81D[*]-300DV	DP41-S, DP25B-S
0 to 500 psid	0 to 34.5 bar	PX81D[*]-500DV	DP41-S, DP25B-S

Comes complete with 5-point NIST traceable calibration.

* Visit us online for compatible meters.

[*] To specify electrical termination, insert "0" for 3 m (10') cable, "1" for twist-lock connector, or "6" for mini DIN connector.

Ordering Examples: PX81D1-010DV, 10 psid differential pressure transducer with 3 mV/V output and twist-lock connector. PT06F10-6S, mating connector (sold separately).

PX81D1-020DV, 20 psid differential pressure transducer with 3 mV/V output and twist-lock connector. PT06F10-6S, mating connector (sold separately).

ACCESSORY

MODEL NO.	DESCRIPTION
PT06F10-6S	Mating connector for PX81D1 series transducers

mV/V OUTPUT METRIC RANGES

mV/V Output
0-350 mbar to 0-35 bar
0-5 to 0-500 psi
Differential Pressure



METRIC
PXM81MD1-350MBARDV,
 shown actual size.

PXM81 Series mV Models



- ✓ High-Accuracy Wet/Wet Differential Pressure
- ✓ All Stainless Steel Construction for Harsh Industrial Environments
- ✓ High Operating Temperature
- ✓ 5-Point Calibration Provided: 0%, 50%, 100%, 50%, 0%

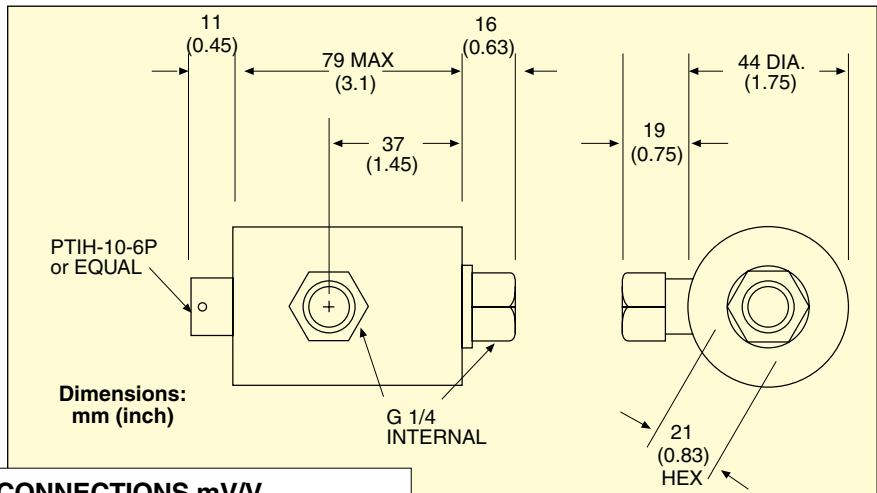

CONNECTIONS mV/V

	PIN	Cable	DIN
+Output	A	Green	2
-Output	B	White	3
-Input	C	Black	GRND
+Input	D	Red	1
Shunt	E	Blue	
Shunt	F	Orange	

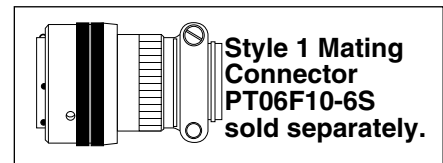

METRIC MODELS

To Order

mV/V OUTPUT WITH G 1/4 PRESSURE CONNECTION, SPECIFY ELECTRICAL TERMINATION

RANGE		MODEL NO.	COMPATIBLE METERS*
DIFFERENTIAL PRESSURE			
0 to 350 mbar	0 to 5 psi	PXM81MD[*]-350mBARDV	DP41-S, DP25B-S
0 to 700 mbar	0 to 10 psi	PXM81MD[*]-700mBARDV	DP41-S, DP25B-S
0 to 1.4 bar	0 to 20 psi	PXM81MD[*]-1.4BARDV	DP41-S, DP25B-S
0 to 3.5 bar	0 to 51 psi	PXM81MD[*]-3.50BARDV	DP41-S, DP25B-S
0 to 7 bar	0 to 102 psi	PXM81MD[*]-007BARDV	DP41-S, DP25B-S
0 to 14 bar	0 to 203 psi	PXM81MD[*]-014BARDV	DP41-S, DP25B-S
0 to 20 bar	0 to 280 psi	PXM81MD[*]-020BARDV	DP41-S, DP25B-S
0 to 35 bar	0 to 508 psi	PXM81MD[*]-035BARDV	DP41-S, DP25B-S

Comes complete with 5-point NIST traceable calibration.

* Visit us online for compatible meters

[*] Insert "0" for 3 m (10') cable, "1" for twist-lock connector or "6" for mini DIN connector.

To order extra cable on cable-style models, add suffix "--(total length in meters)M" and additional cost/m beyond the standard 3 m (10') length.

Ordering Examples: **PXM81MD0-014BARDV-10M**, 14 bar differential pressure transducer with 3 mV/V output and 10 m (32') cable, **PXM81MD1-350mBARDV**, 350 mbar differential pressure transducer with 3 mV/V output and twist-lock connector. **PT06F10-6S**, mating connector (sold separately).

0 to 5 Vdc OUTPUT STANDARD RANGES

0 to 5 Vdc Output
0-2 to 0-500 psi
(0-140 mbar to 0-35 bar)
Differential Pressure

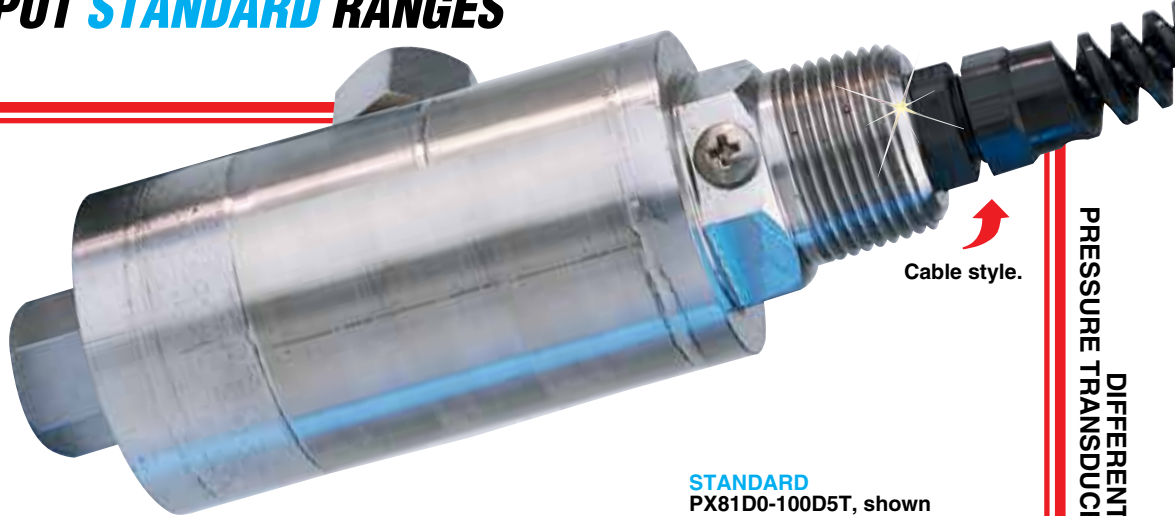

PX81 Series
5 V Models



Standard

STANDARD
PX81D0-100D5T, shown
actual size.

DIFFERENTIAL PRESSURE TRANSDUCERS

- ✓ High-Accuracy Wet/Wet Differential Pressure
- ✓ All Stainless Steel Construction for Harsh Industrial Environments
- ✓ High Operating Temperature
- ✓ 5-Point Calibration Provided: 0%, 50%, 100%, 50%, 0%

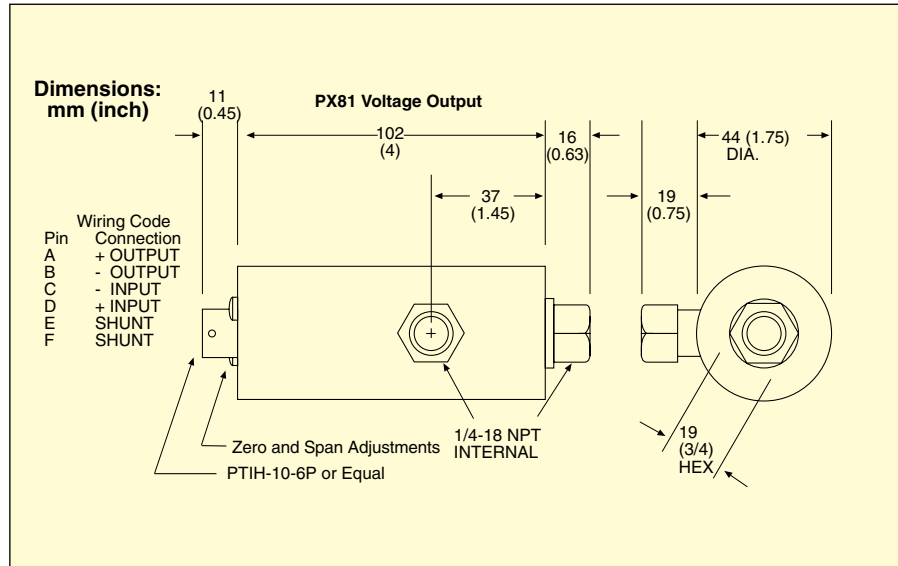

CONNECTIONS 5 V

	PIN	Cable	DIN
+Output	A	Green	2
-Output	B	White	3
-Input	C	Black	GRND
+Input	D	Red	4
Shunt	E	Orange	
Shunt	F	Blue	

STANDARD MODELS

To Order			
MODELS WITH 0 to 5 Vdc OUTPUT			
	RANGE	MODEL NO.	COMPATIBLE METERS*
	0 to 2 psid	0 to 0.14 bar	PX81D[*]-002D5T DP41-E, DP25B-E, DP24-E
	0 to 5 psid	0 to 0.34 bar	PX81D[*]-005D5T DP41-E, DP25B-E, DP24-E
	0 to 10 psid	0 to 0.69 bar	PX81D[*]-010D5T DP41-E, DP25B-E, DP24-E
	0 to 20 psid	0 to 1.4 bar	PX81D[*]-020D5T DP41-E, DP25B-E, DP24-E
	0 to 50 psid	0 to 3.4 bar	PX81D[*]-050D5T DP41-E, DP25B-E, DP24-E
	0 to 100 psid	0 to 6.9 bar	PX81D[*]-100D5T DP41-E, DP25B-E, DP24-E
	0 to 200 psid	0 to 13.8 bar	PX81D[*]-200D5T DP41-E, DP25B-E, DP24-E
	0 to 300 psid	0 to 20.7 bar	PX81D[*]-300D5T DP41-E, DP25B-E, DP24-E
	0 to 500 psid	0 to 34.5 bar	PX81D[*]-500D5T DP41-E, DP25B-E, DP24-E

Comes complete with 5-point NIST traceable calibration.

* Visit us online for compatible meters.

[*] To specify electrical termination, insert "0" for 3 m (10') cable, "1" for twist-lock connector, or "6" for mini DIN connector.

Ordering Examples: **PX81D1-010D5T**, 10 psi differential pressure transducer with 0 to 5 Vdc output and twist-lock connector. **PT06F10-6S**, mating connector (sold separately).

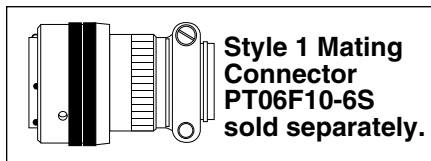

0 to 5 Vdc OUTPUT **METRIC** RANGES

0 to 5 Vdc Output
0-160 mbar to 0-35 bar
0-2 to 0-500 psi
Differential Pressure

PXM81 Series 5 V Model



- ✓ High-Accuracy Wet/Wet Differential Pressure
- ✓ All Stainless Steel Construction for Harsh Industrial Environments
- ✓ High Operating Temperature
- ✓ 5-Point Calibration Provided: 0%, 50%, 100%, 50%, 0%

CONNECTIONS 5 V			
	PIN	Cable	DIN
+Output	A	Green	2
-Output	B	White	3
-Input	C	Black	GRND
+Input	D	Red	4
Shunt	E	Orange	
Shunt	F	Blue	

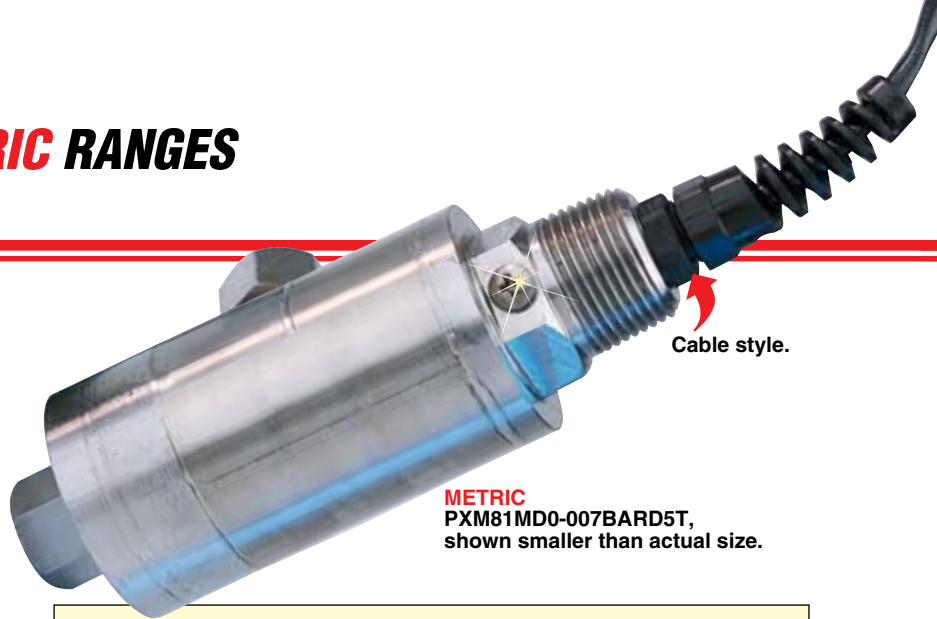

METRIC
PXM81MD0-007BARD5T,
 shown smaller than actual size.

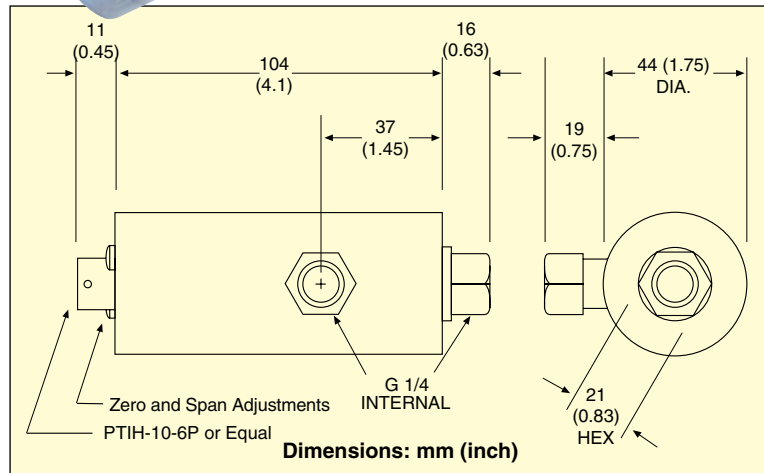

METRIC MODELS

To Order

0 to 5 Vdc OUTPUT WITH G ¼ PRESSURE CONNECTION, SPECIFY ELECTRICAL TERMINATION

RANGE		MODEL NO.	COMPATIBLE METERS*
DIFFERENTIAL PRESSURE			
0 to 160 mbar	0 to 2.3 psi	PXM81MD[*]-160mBARD5T	DP41-E, DP25B-E, DP24-E
0 to 350 mbar	0 to 5 psi	PXM81MD[*]-350mBARD5T	DP41-E, DP25B-E, DP24-E
0 to 700 mbar	0 to 10 psi	PXM81MD[*]-700mBARD5T	DP41-E, DP25B-E, DP24-E
0 to 1.4 bar	0 to 20 psi	PXM81MD[*]-1.40BARD5T	DP41-E, DP25B-E, DP24-E
0 to 3.5 bar	0 to 51 psi	PXM81MD[*]-3.50BARD5T	DP41-E, DP25B-E, DP24-E
0 to 7 bar	0 to 102 psi	PXM81MD[*]-007BARD5T	DP41-E, DP25B-E, DP24-E
0 to 14 bar	0 to 203 psi	PXM81MD[*]-014BARD5T	DP41-E, DP25B-E, DP24-E
0 to 20 bar	0 to 290 psi	PXM81MD[*]-020BARD5T	DP41-E, DP25B-E, DP24-E
0 to 35 bar	0 to 508 psi	PXM81MD[*]-035BARD5T	DP41-E, DP25B-E, DP24-E

Comes complete with 5-point NIST traceable calibration.

* Visit us online for compatible meters.

[*] Insert "0" for 3 m (10') cable, "1" for twist-lock connector or "6" for mini DIN connector.

To order extra cable on cable-style models, add suffix "-(Total length in meters)M" and additional cost/m beyond the standard 3 m (10') length.

Ordering Examples: PXM81MD0-014BAR5T-10M, 14 bar differential pressure transmitter with 0 to 5 Vdc output and 10 m (32') cable.

PXM81MD1-350mBAR5T, 350 millibar differential pressure transmitter with 0 to 5 Vdc output and twist-lock connector. PT06F10-6S, mating connector (sold separately).

4 to 20 mA OUTPUT STANDARD RANGES

4 to 20 mA Output
0-2 to 0-500 psid
0-140 mbar to 0-35 bar
Differential Pressure

PX81 Series

4 to 20 mA Models



STANDARD
 PX81D0-005DI, shown smaller than actual size.

DIFFERENTIAL PRESSURE TRANSDUCERS **B**

- ✓ High-Accuracy Wet/Wet Differential Pressure
- ✓ All Stainless Steel Construction for Harsh Industrial Environments
- ✓ High Operating Temperature
- ✓ 5-Point Calibration Provided: 0%, 50%, 100%, 50%, 0%

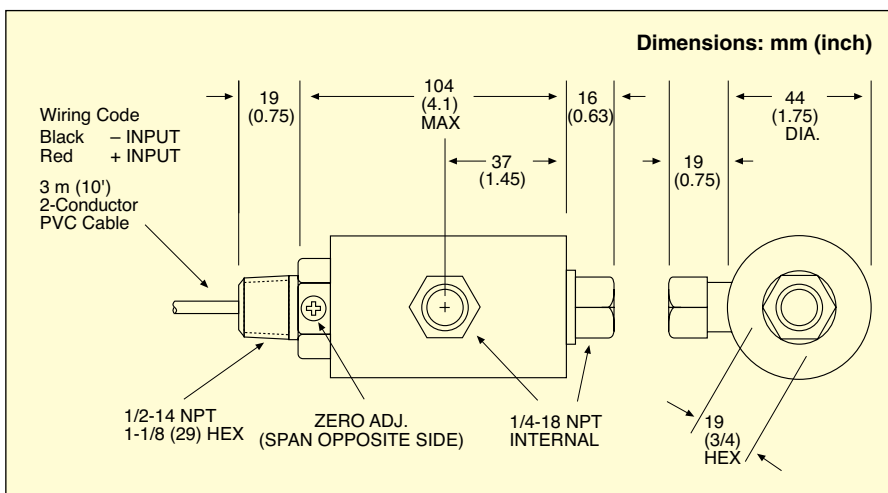

CONNECTIONS 4 to 20 mA

	PIN	Cable	DIN
+Input	A	Red	1
-Input	B	Black	2

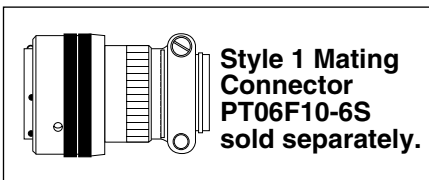

STANDARD MODELS

To Order			
MODELS WITH 4 to 20 mA OUTPUT WITH 1/4 NPT FITTING			
RANGE		MODEL NO.	COMPATIBLE METERS*
0 to 2 psid	0 to 0.14 bar	PX81D[*]-002DI	DP41-E, DP25B-E, DP24-E
0 to 5 psid	0 to 0.34 bar	PX81D[*]-005DI	DP41-E, DP25B-E, DP24-E
0 to 20 psid	0 to 1.4 bar	PX81D[*]-020DI	DP41-E, DP25B-E, DP24-E
0 to 50 psid	0 to 3.4 bar	PX81D[*]-050DI	DP41-E, DP25B-E, DP24-E
0 to 100 psid	0 to 6.9 bar	PX81D[*]-100DI	DP41-E, DP25B-E, DP24-E
0 to 200 psid	0 to 13.8 bar	PX81D[*]-200DI	DP41-E, DP25B-E, DP24-E
0 to 300 psid	0 to 20.7 bar	PX81D[*]-300DI	DP41-E, DP25B-E, DP24-E
0 to 500 psid	0 to 34.5 bar	PX81D[*]-500DI	DP41-E, DP25B-E, DP24-E

Comes complete with 5-point NIST traceable calibration.

* Visit us online for compatible meters.

[*] To specify electrical termination, insert "0" for 3 m (10') cable, "1" for twist-lock connector, or "6" for mini DIN connector.

Ordering Examples: PX81D1-005DI, 5 psi differential pressure transmitters with 4 to 20 mA output and twist-lock connector.

PT06F10-6S, mating connector (sold separately).

4 to 20 mA OUTPUT **METRIC** RANGES

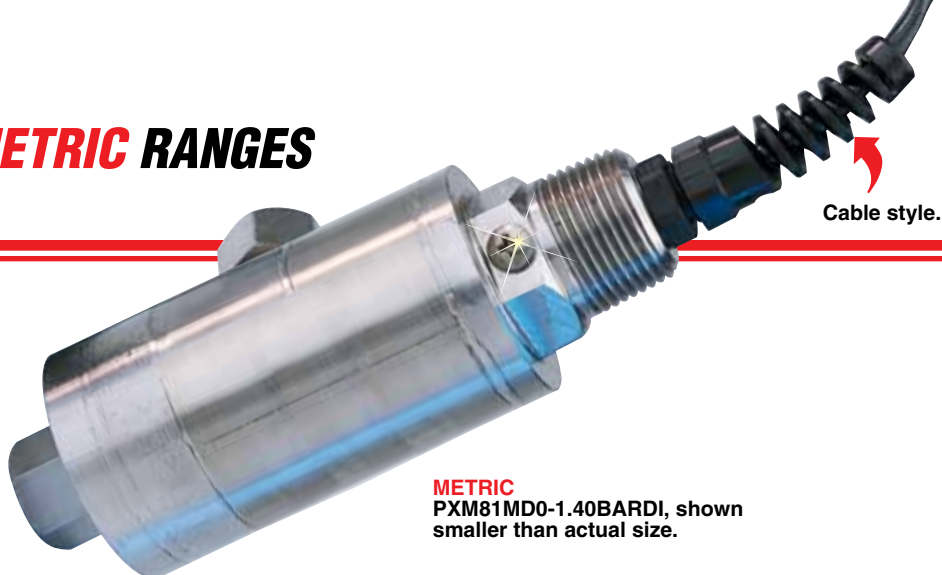

4 to 20 mA Output
0-160 mbar to 0-35 bar
0-2 to 0-500 psi
Differential Pressure

PXM81 Series 4 TO 20 mA Models



- ✓ High-Accuracy Wet/Wet Differential Pressure
- ✓ All Stainless Steel Construction for Harsh Industrial Environments
- ✓ High Operating Temperature
- ✓ 5-Point Calibration Provided: 0%, 50%, 100%, 50%, 0%

METRIC
PXM81MD0-1.40BARDI, shown smaller than actual size.

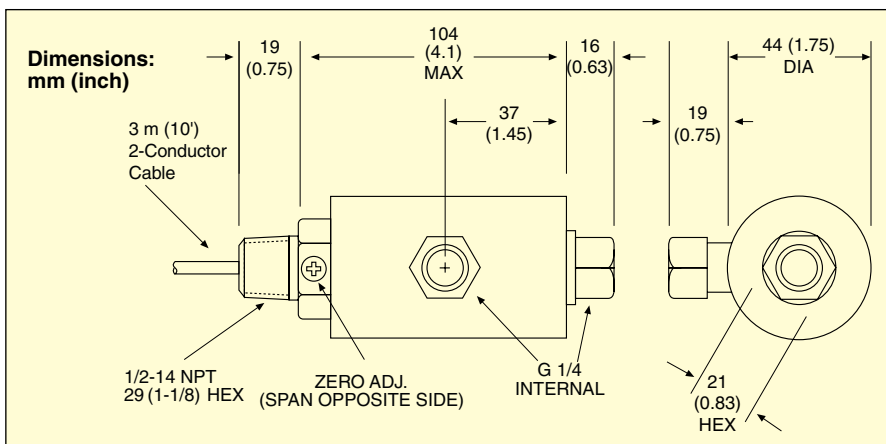

CONNECTIONS 4 to 20 mA			
	PIN	Cable	DIN
+Input	A	Red	1
-Input	B	Black	2

METRIC MODELS

To Order			
4 to 20 mA OUTPUT WITH G 1/4 PRESSURE CONNECTION, SPECIFY ELECTRICAL TERMINATION			
RANGE		MODEL NO.	COMPATIBLE METERS*
DIFFERENTIAL PRESSURE			
0 to 160 mbar	0 to 2.3 psi	PXM81MD[*]-160mBARDI	DP41-E, DP25B-E, DP24-E
0 to 350 mbar	0 to 5 psi	PXM81MD[*]-350mBARDI	DP41-E, DP25B-E, DP24-E
0 to 700 mbar	0 to 10 psi	PXM81MD[*]-700mBARDI	DP41-E, DP25B-E, DP24-E
0 to 1.4 bar	0 to 20 psi	PXM81MD[*]-1.40BARDI	DP41-E, DP25B-E, DP24-E
0 to 3.5 bar	0 to 51 psi	PXM81MD[*]-3.50BARDI	DP41-E, DP25B-E, DP24-E
0 to 7 bar	0 to 102 psi	PXM81MD[*]-007BARDI	DP41-E, DP25B-E, DP24-E
0 to 14 bar	0 to 203 psi	PXM81MD[*]-014BARDI	DP41-E, DP25B-E, DP24-E
0 to 20 bar	0 to 290 psi	PXM81MD[*]-020BARDI	DP41-E, DP25B-E, DP24-E
0 to 35 bar	0 to 508 psi	PXM81MD[*]-035BARDI	DP41-E, DP25B-E, DP24-E

Comes complete with 5-point NIST traceable calibration.

[*] Insert "0" for 3 m (10') cable, "1" for twist-lock connector or "6" for mini DIN connector. * Visit us online for compatible meters.

To order extra cable on cable-style models, add suffix "-(Total length in meters)M" and additional cost/m beyond the standard 3 m (10') length.

Ordering Examples: PXM81MD0-014BARDI-10M, 14 bar differential pressure transmitter with 4 to 20 mA output and 10 m (32') cable.

PXM81MD1-350mBARDI, 350 mbar differential pressure transmitter with 4 to 20 mA output and a twist-lock connector. PT06F10-6S, mating connector (sold separately).