

Unique Surface Probes

Model No. 88222(*)

Right-angle probe ideal for measuring moving or rotating surfaces. Can be used in paper, fiber, printing, iron and steel industries. Max surface temperature of 250°C (480°F).

Replaceable Element supplied free, for additional elements order **Model No. 88222(*)-RE**

Model No. 88223(*)

Surface probe designed for measuring moving or rotating surfaces. Ideal for surfaces perpendicular to the probe handle. Max surface temperature of 250°C (480°F).

Replaceable Element supplied free, for additional elements order **Model No. 88223(*)-RE**

Model 98221K shown.



TAS adaptor

All models supplied with a molded SMP or SMPW subminiature male connector. TAS adapter sold separately.

Model No. 88221(*)

Ideal for measurements of moving or stationary flat, smooth surfaces. Max surface temperature of 250°C (480°F) allows for use on both metal and plastic surfaces. Surface velocity of moving surfaces should not exceed 90 m (300') per minute.

Replaceable Element supplied free, for additional elements order **Model No. 88221(*)-RE**

Model No. 98221(*) with Swivel Head

All the probes in this series meet the Standard Limits of Error.

Adaptor Sold Separately

TAS-K-3

TAS-E-3

All models shown smaller than actual size.

Model No. 88220(*)

Model No. 98220(*) with Swivel Head

Visit us online for dimensions. Unique swivel head design available 98000 probes.

Ideal for measuring the temperature of rollers 100 to 152 mm (4 to 6") in diameter, with velocities to 61 m (200') per minute. Max surface temperature of 250°C (480°F).

Replaceable Element supplied free, for additional elements order **Model No. 88220(*)-RE**

Head Rotates 180° and Swivels

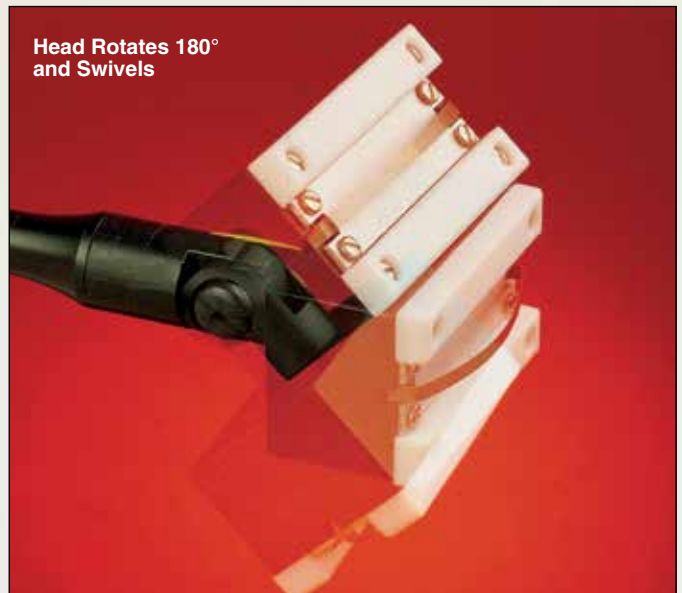

Ordering Example: 98220E, Type E (CHROMETM-Constantan) Surface probe with swivel head, rated to 250°C (480°F). 88222K, Type K (CHROMETM-ALOMEGA) Right-angle surface probe, rated to 250°C (480°F).



Model No. 88226(*)

Model No. 98226(*) with Swivel Head

Right-angle probe for rotating rollers of 152 to 300 mm (6 to 12") in diameter. 61 m (200') per minute max velocity, with 250°C (480°F) max surface temperature.
Replaceable Element supplied free, for additional elements order Model No. 88226()-RE*



TAS adaptor
 All models supplied with a molded SMP or SMPW subminiature male connector. TAS adapter sold separately.

Adaptor Sold Separately
TAS-K-3
TAS-E-3

Model No. 88224(*)

Right-angle probe for rotating rollers from 100 to 152 mm (4 to 6") in diameter. Max surface temperature of 250°C (480°F).
Replaceable Element supplied free, or additional elements, order Model No. 88224()-RE*



Model No. 98225(*) with Swivel Head

Right-angle probe for rotating rollers of 300 to 584 mm (12 to 23") in diameter. 30 m (100') per minute max velocity, with 250°C (480°F) max surface temperature.
Replaceable Element supplied free, for additional elements order Model No. 88225()-RE*

Model No. 88225(*)



All models shown smaller than actual size.

Now Available!
M8/M12 CONNECTORS



*** Specify Calibration:**
 K: CHROMEGLA™-ALOMEGA™
 E: CHROMEGLA™-Constantan

For a male straight M8 plug add "M8-S-M" to the model number for additional cost, for a male straight M12 plug add "M12-S-M" to the model number for additional cost.
 For a male right-angled M8 plug add "M8-R-M" to the model number for additional cost, for a male right-angled M12 plug add "M12-S-M" to the model number for additional cost.

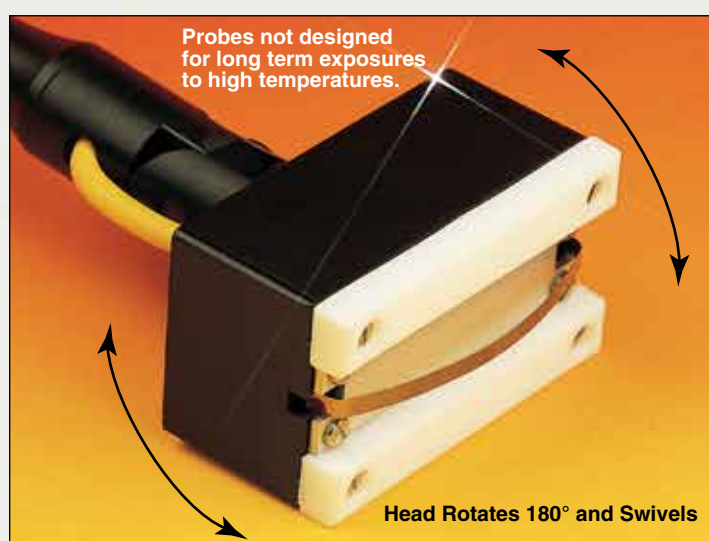

Probes not designed for long term exposures to high temperatures.

Head Rotates 180° and Swivels

Model No. 88227(*)

Model No. 98227(*) with Swivel Head

For surface measurements with end braces to minimize flexing due to a moving surface; this also prolongs probe life. PFA sliders ensure smooth operation on both metal and plastic surfaces. 61 meters (200') per minute max velocity, 250°C (480°F) max surface temperature.



Ordering Example: 98227K is a model 98227 swivel head surface probe in Type K thermocouple.

Replaceable Element supplied free, for additional elements order Model No. 88227()-RE*

Unique Surface Probes Series 88000

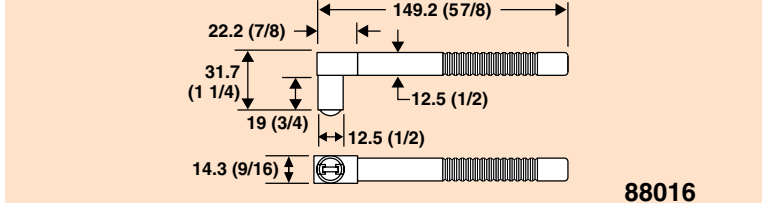
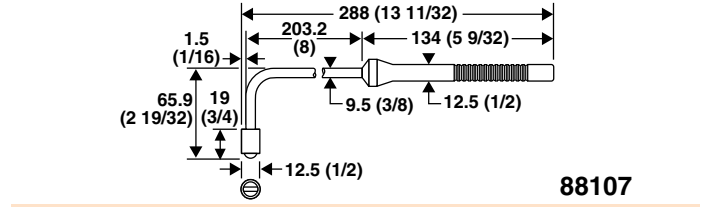
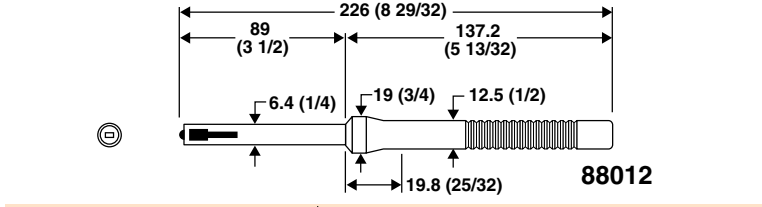
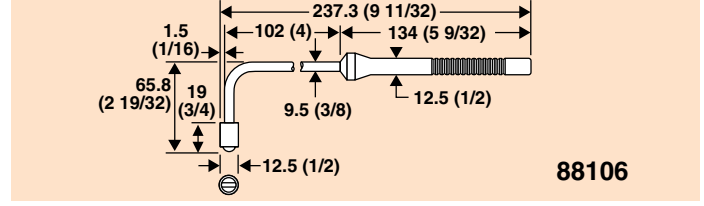
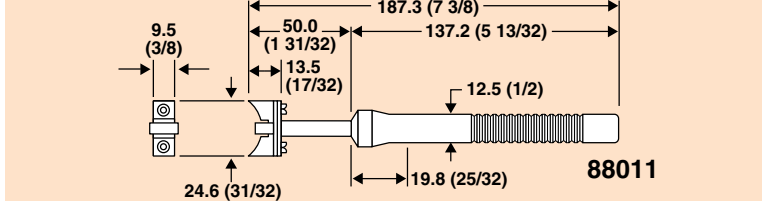
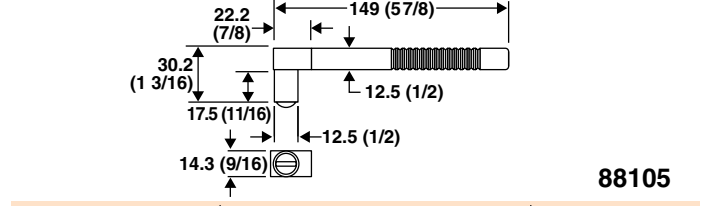
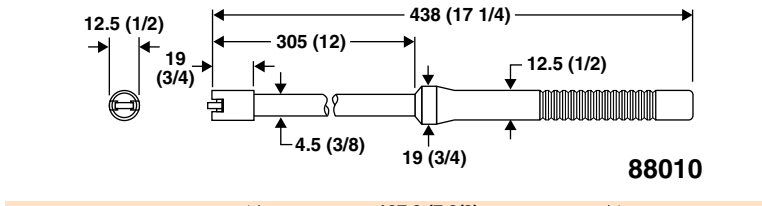
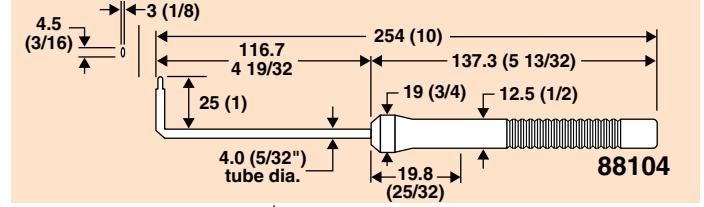
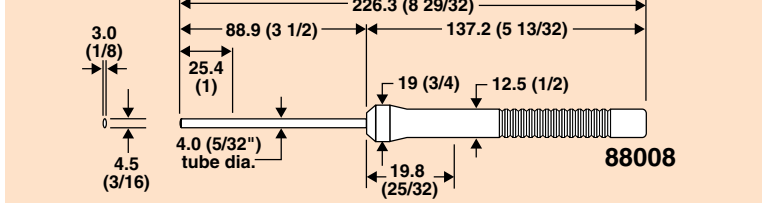
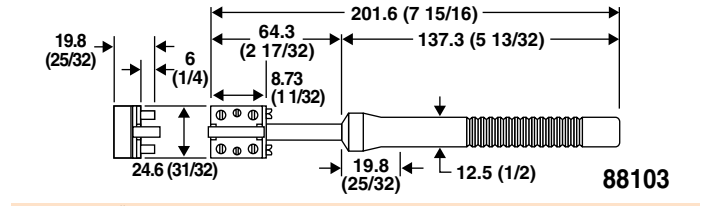
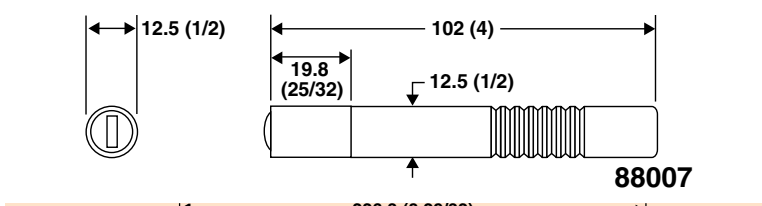
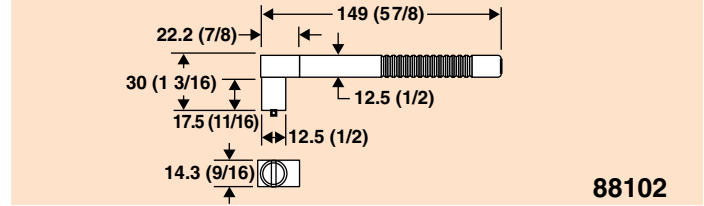
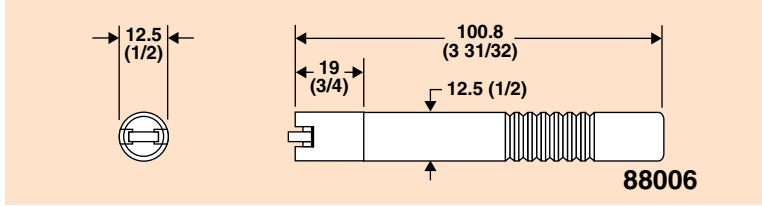
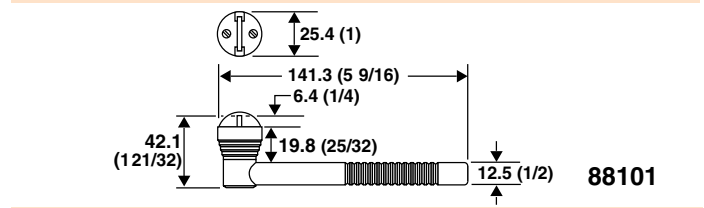
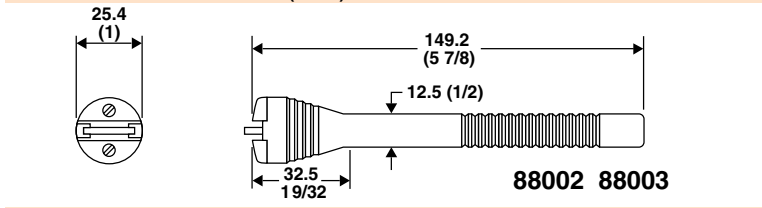
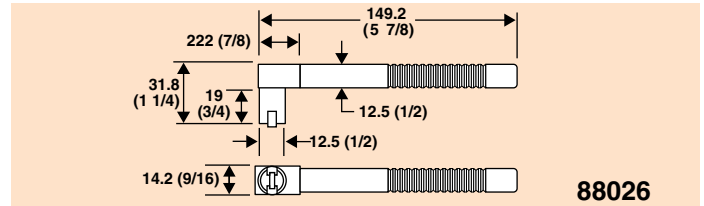
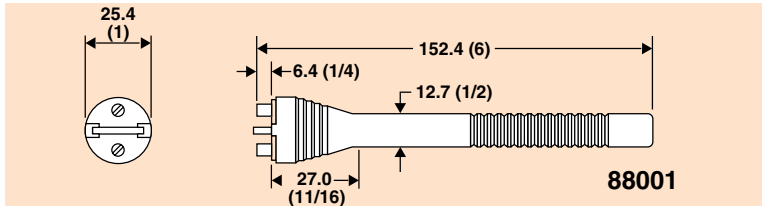

Dimensions: mm (in)

Unique Surface Probes Series 88000/98000

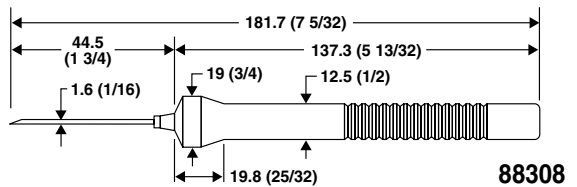
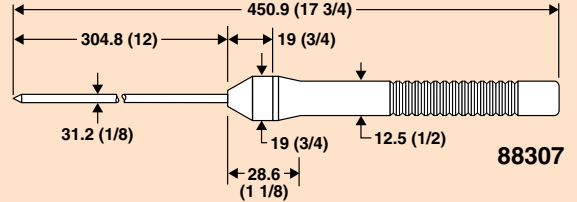
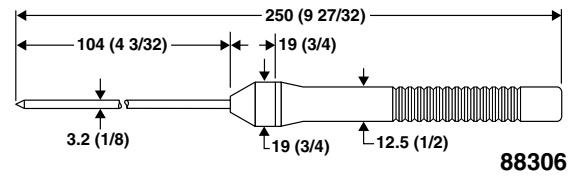
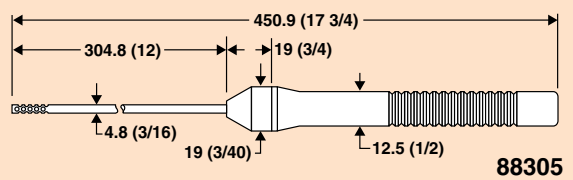
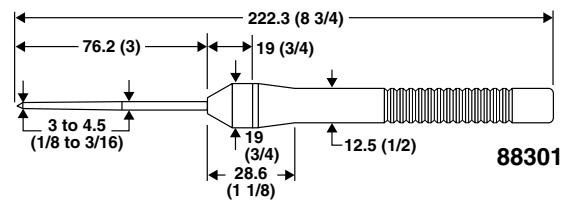
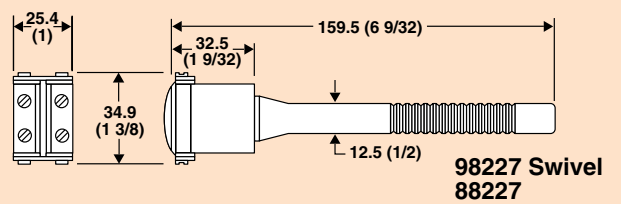
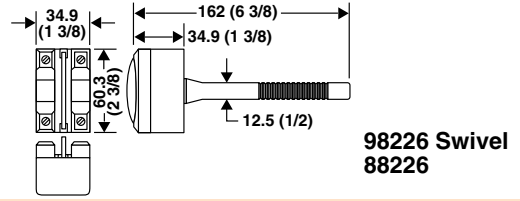
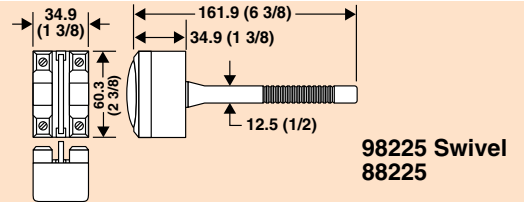
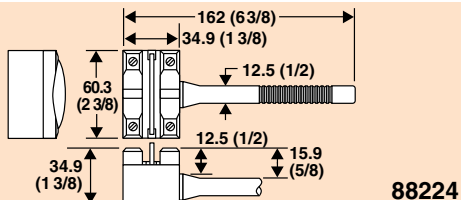
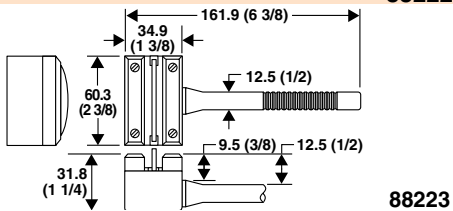
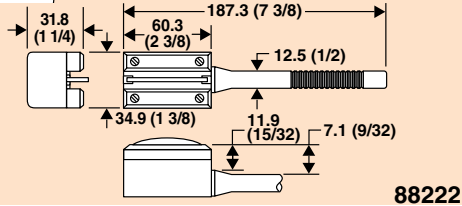
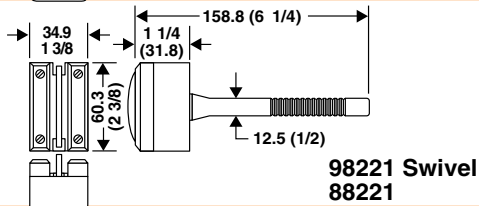
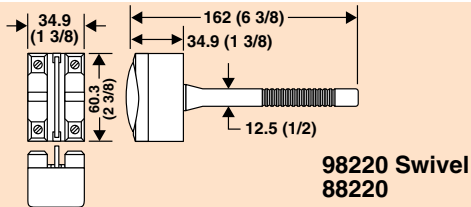
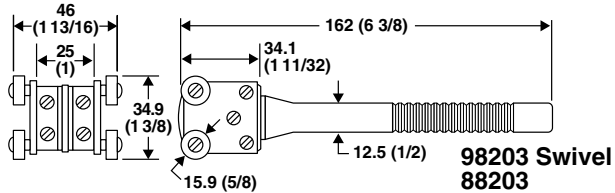
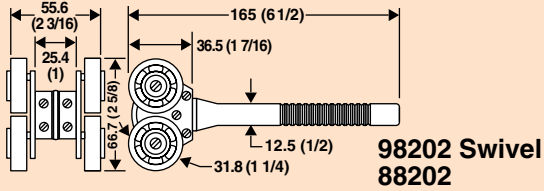
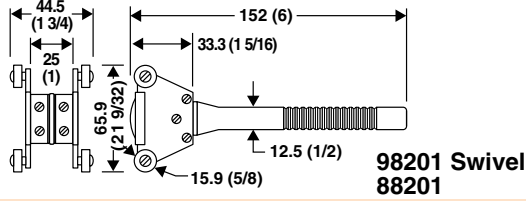
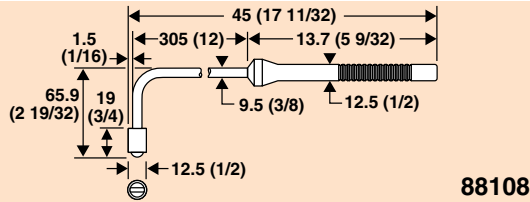

Dimensions: mm (in)

Model 88009

1.5 (0.06) Max. Element Deflection

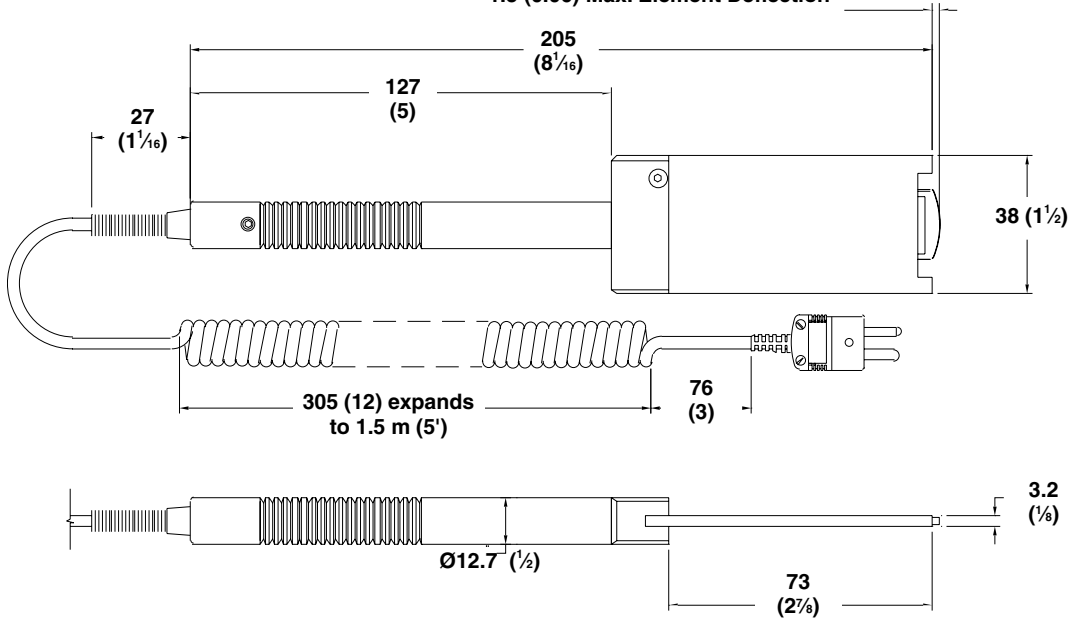

Model 88014

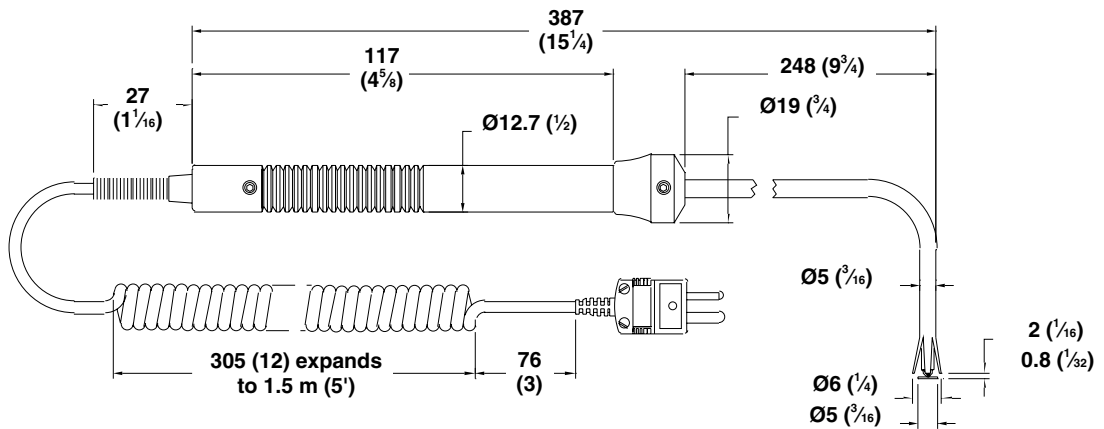

Model 88013

