

Unique Surface Probes



Adaptor Sold Separately
TAS-K-3
TAS-E-3

All the probes in this series meet the Standard Limits of Error.

**Model No. 88203(*)
Model No. 98203(*)
with Swivel Head**

For rotating, smooth metallic surfaces of 229 to 610 mm (9 to 24") in diameter. 90 m (300') per minute maximum surface velocity. Maximum surface temperature of 205°C (400°F).

Replaceable Element supplied free, for additional elements order Model No. 88203()-RE.*



TAS adaptor
All models supplied with a molded SMP or SMPW subminiature male connector. TAS adaptor sold separately.

A roller-surface probe, for use on moving or rotating, smooth surfaces with a velocity up to 61 m (200') per minute. Maximum surface temperature of 205°C (400°F).

**Model No. 88201(*)
Model No. 98201(*)
with Swivel Head**

Replaceable Element supplied free, for additional elements order Model No. 88201()-RE.*

Visit us online for dimensions.

**Model No. 88202(*)
Model No. 98202(*)
with Swivel Head**

A roller-surface probe, ideal for measuring outside wall temperatures of smooth plastic or steel piping. Can be used on moving or rotating surfaces of 559 to 1524 mm (22 to 60") in diameter, with 90 m (300') per minute maximum surface velocity. Maximum surface temperature of 205°C (400°F).

Replaceable Element supplied free, for additional elements order Model No. 88202()-RE.*
Ordering Example: 98201K, style 98201 swivel head roller surface probe in Type K thermocouple.

*** Specify Calibration:**
K: CHROMEGA™-ALOMEGA™
E: CHROMEGA™-Constantan



Unique Surface Probes Series 88000

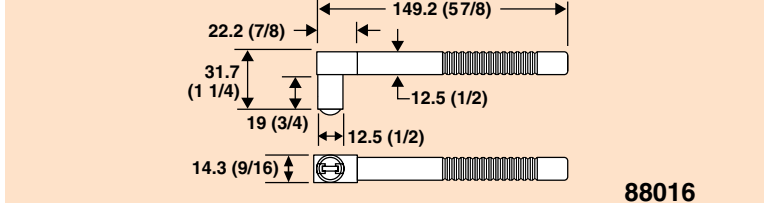
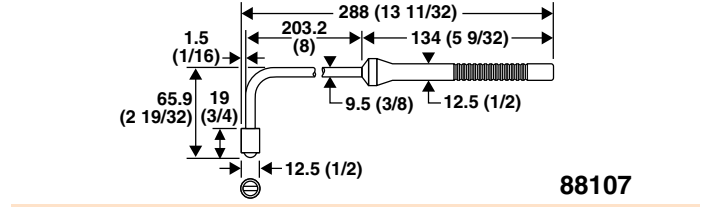
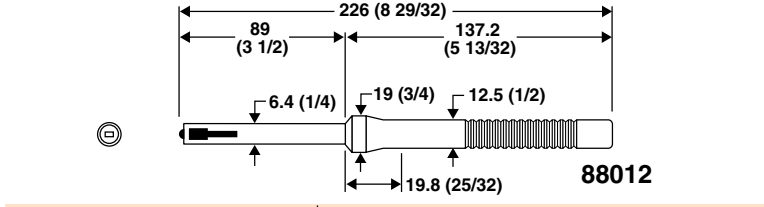
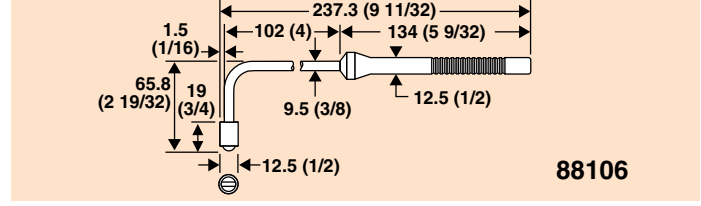
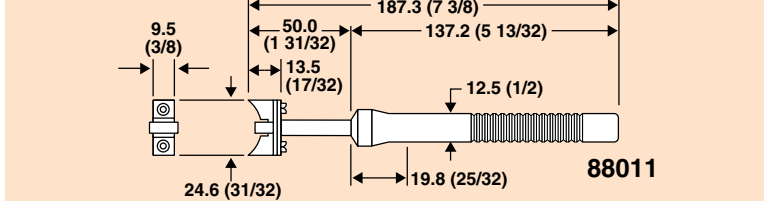
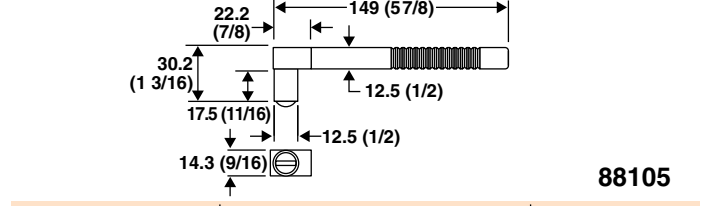
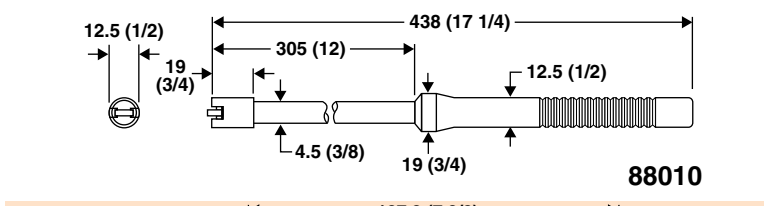
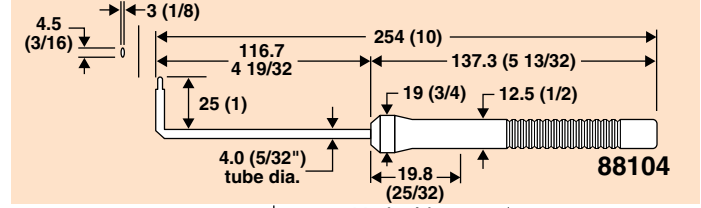
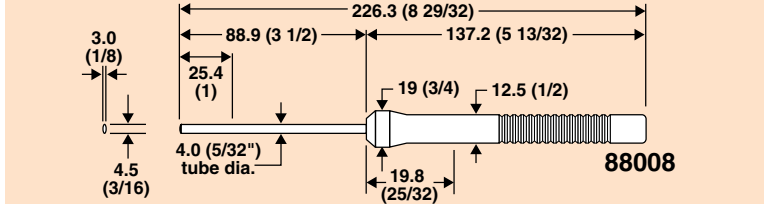
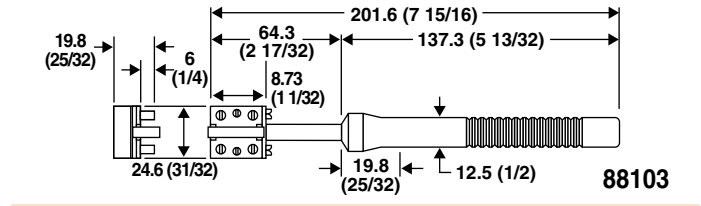
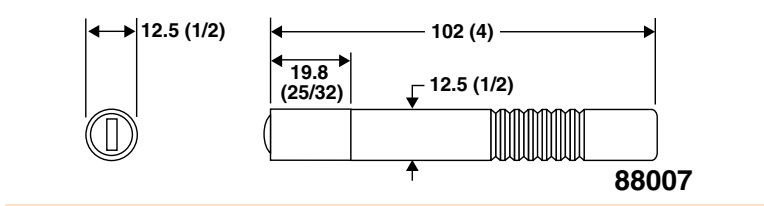
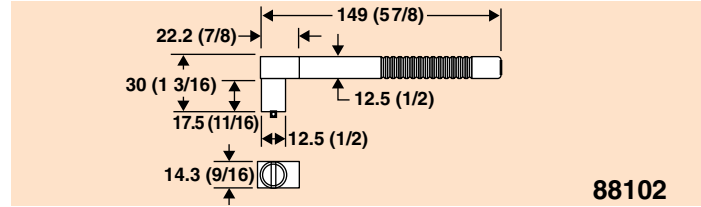
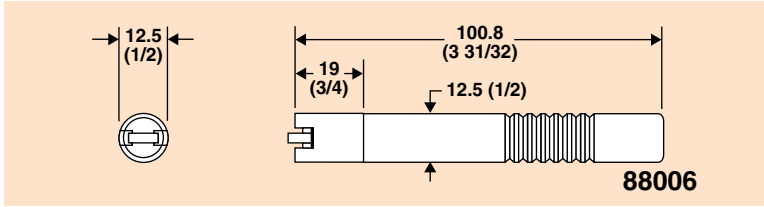
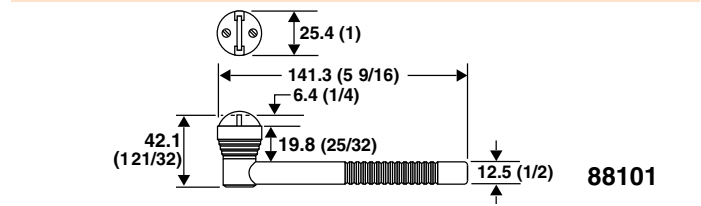
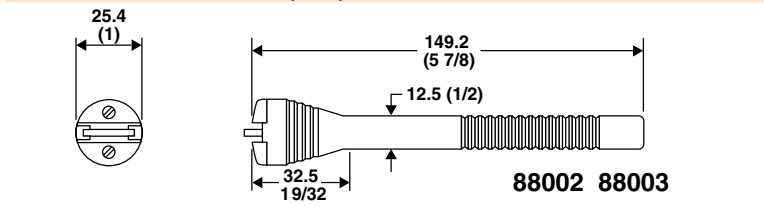
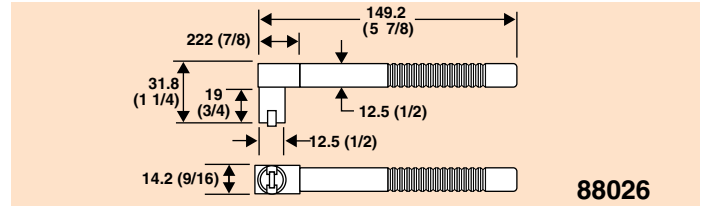
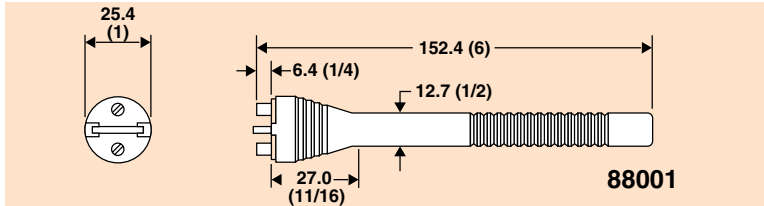

Dimensions: mm (inches)

Unique Surface Probes Series 88000/98000

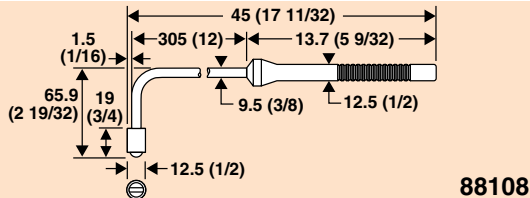

88108

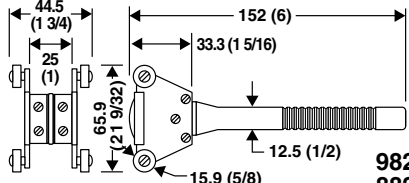

98201 Swivel
88201

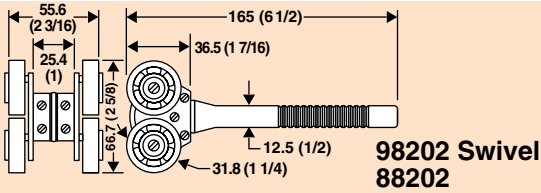

98202 Swivel
88202

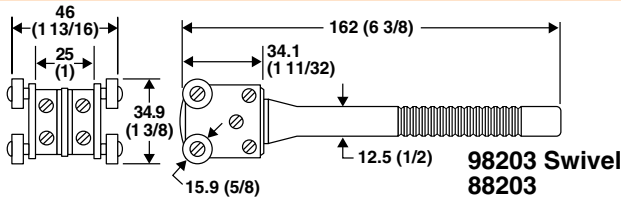

98203 Swivel
88203

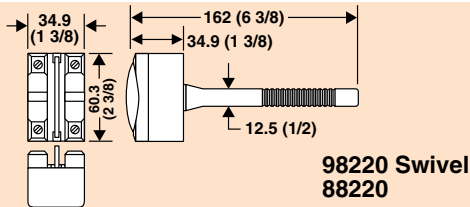

98220 Swivel
88220

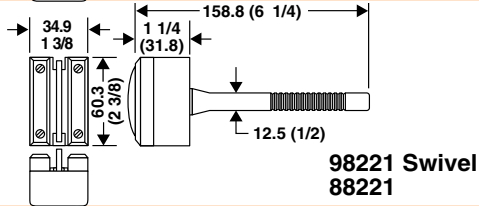

98221 Swivel
88221

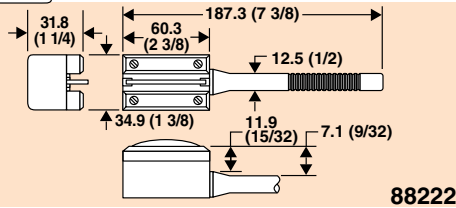

88222

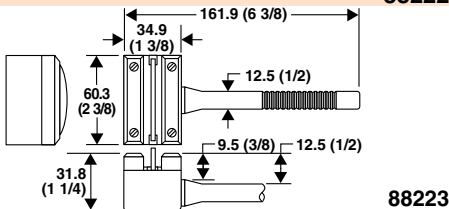

88223

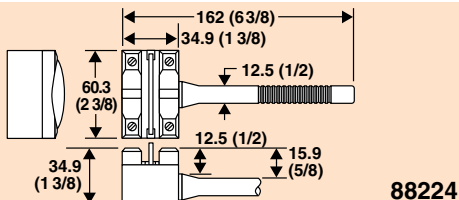

88224

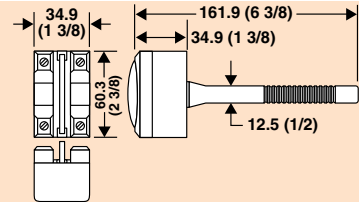

98225 Swivel
88225

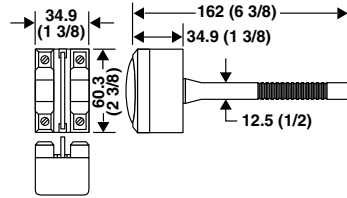

98226 Swivel
88226

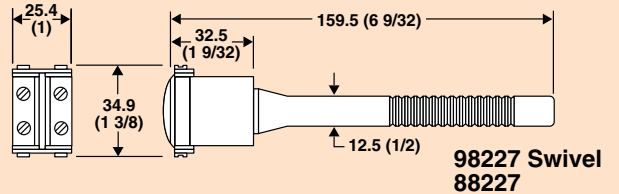

98227 Swivel
88227

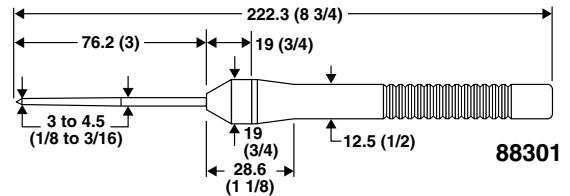

88301

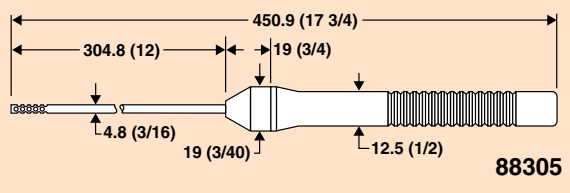

88305

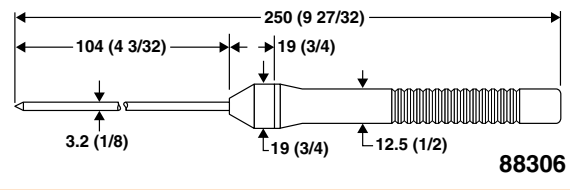

88306

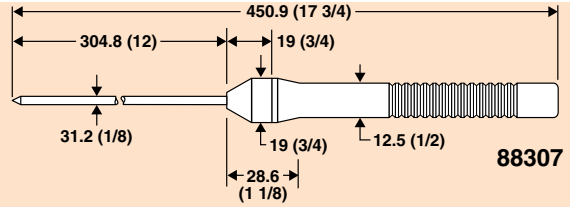

88307

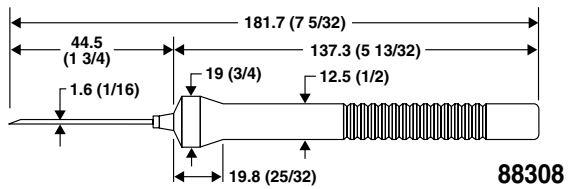

88308

Dimensions: mm (inches)

Model 88009

1.5 (0.06) Max. Element Deflection

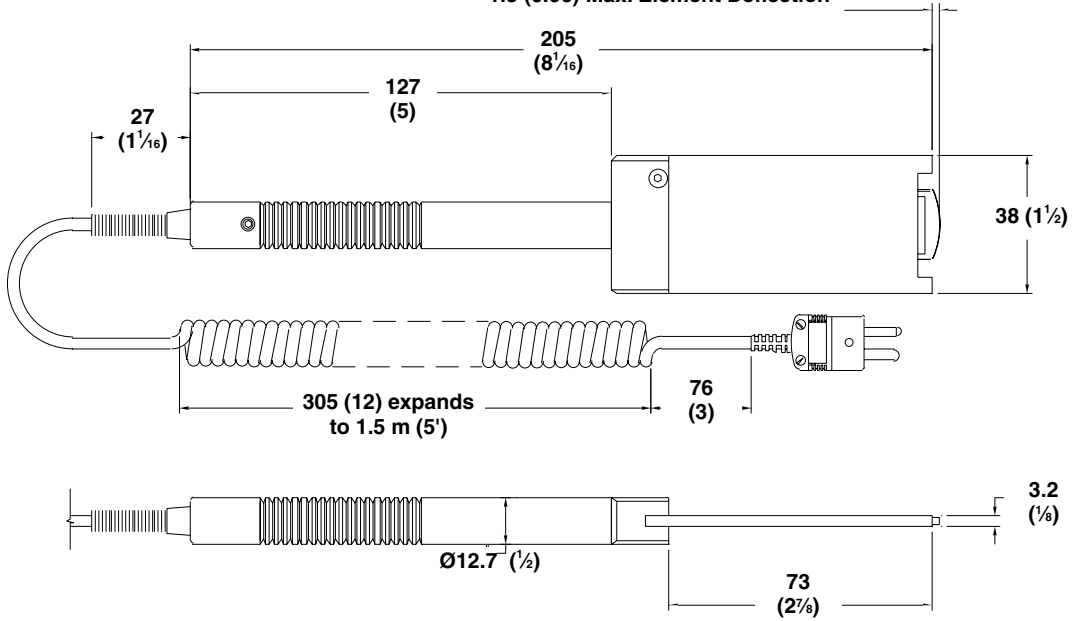

Model 88014

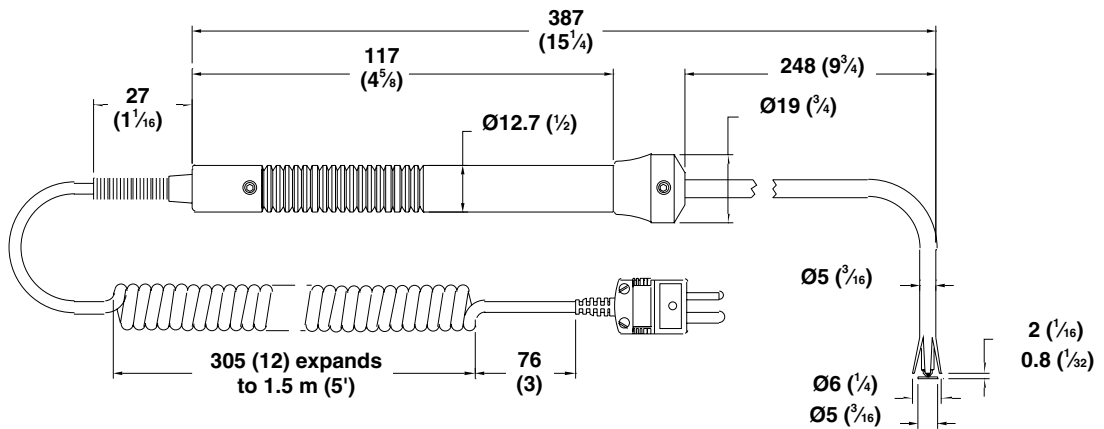

Model 88013

